

Xive®

Surgical Manual



Versatility and ease

For more than a decade, the Xive implant system has provided full restorative options. From the narrowest gap to the fully atrophied edentulous jaw, in hard or soft bone, from single-stage to two-stage protocols, from subgingival to transgingival healing, from immediate to delayed loading - with Xive, you decide which treatment concept to select.

The basis for this freedom of choice, both surgically and prosthetically, is the combination of outstanding key features that provide versatility and ease.

Please read this manual carefully before using the system for the first time and observe the directions and notes in the instructions for use of the system components and instruments at all times. We also recommend that all users attend a training course in the system before using a new implant system for the first time.

CONTENTS

System concept

Comprehensive implant selection	4
Bone-specific preparation protocol	9
Prosthetic versatility	10

Treatment planning

Aspects of treatment planning	12
Conventional treatment planning	14
Computer-guided treatment planning	17

Implant site preparation**Rotary preparation**

Xive surgical kits	18
Washtray	20
Xive instrument set	22
Step-by-step: Preparation with twist drills	30

Mechanical preparation (osteotomy)

Xive instrument set	36
Step-by-step: Sinus floor elevation with Xive BoneCondensers	38

Implant placement and restoration**Xive S**

Implant packaging	40
Xive S instrument set	42
Step-by-step: Xive S implant placement	44
Step-by-step: Submerged healing	48
Friadent TempBase	50
Step-by-step: Index impression	52
Step-by-step: Transgingival healing with temporary denture	55
Step-by-step: Temporary restoration of multiple implant placements	58
Step-by-step: Transgingival healing with gingiva former	60

Xive TG

Xive TG instrument set	62
Step-by-step: Xive TG implant placement	63
Transgingival healing	64
Immediate implant restoration	64

Guided Surgery

Simplant SAFE Guide - Xive	67
Xive GS (Guided Surgery) instrument set	68
Step-by-step: Placement of the Simplant SAFE Guide	73
Step-by-step: Preparation of the implant site	77
Step-by-step: Placement of the implant	80

System concept

Comprehensive implant selection

Indications

- Edentulous spans
- Free-end edentulism
- Edentulous jaw

Prosthetic concept

- Single-tooth replacement
- Fixing bridges and prostheses
- Xive D 3.0: single-tooth replacement in the front tooth region and splinted single-tooth restorations

Type of prosthetic restoration

- Two-stage procedure
- Non-functional immediate loading
- Functional immediate restoration with splinting of four screw implants in the mandible (not Xive D 3.0)

Time of implant placement

- Immediate implant placement
- Delayed immediate implant placement
- Late implant placement

Xive® implant diameters and lengths

The narrowest gap or edentulous jaw, hard or soft bone, single-session or two-session, immediate loading or delayed loading – with the comprehensive range of implants from 3.0 mm up to 5.5 mm diameter and 8 mm up to 18 mm length, the bone-specific preparation protocol and wide range of prosthetic options available with the system, which is appreciated by dental technicians all over the world, Xive helps you achieve an outstanding safe and predictable result in every case.

Xive implants adapt to variations in jaw anatomy with a wide range of diameters and lengths that combine with the cylindrical implant body to make optimum use of the available bone volume in even anatomically complex situations. In many cases additional grafting procedures are unnecessary.

Besides the subgingival Xive S cylindrical screw implants, the Xive implant range includes the option of transgingival Xive TG implants. The endosseous section of both types of implants is identical, which means that preparation for both types uses the same instruments and the type of implant can be decided during the surgical procedure.



Color-coding

A separate color is allocated to every Xive implant diameter, and it can be found on all implant packages, instruments and prosthetic components. The color-coding makes it easy to identify the diameter and select the right prosthetic components without danger of confusion.



Diameter	3.0 mm	3.4 mm	3.8 mm	4.5 mm	5.5 mm	
Xive S	Lengths	-	-	8 mm	8 mm	8 mm
		-	9.5 mm	9.5 mm	9.5 mm	9.5 mm
		11 mm	11 mm	11 mm	11 mm	11 mm
		13 mm	13 mm	13 mm	13 mm	13 mm
		15 mm	15 mm	15 mm	15 mm	15 mm
		-	18 mm	18 mm	18 mm	-

Diameter	3.4 mm	3.8 mm	4.5 mm	
Xive TG	Lengths	-	8 mm	8 mm
		9.5 mm	9.5 mm	9.5 mm
		11 mm	11 mm	11 mm
		13 mm	13 mm	13 mm
		15 mm	15 mm	15 mm
		-	-	-

Comprehensive implant selection

Endosseous Xive® implant design

The Xive implant design with the combination of a cylindrical implant body and special thread design guarantees safe and atraumatic implant placement, even in cortical bone.

Superior primary stability can be achieved in all bone qualities. The patented specific thread design with a condensing crestal section is a component of the bone-specific Xive preparation protocol (see page 9).

- Crestal: expanded cylindrical implant body with condensing thread section
- Apical: self-tapping thread with apically increasing thread depth

The extension of the implant shoulder tightly seals the cervical gap between bone and implant and makes it easy to place the prosthetic components.

1 | Unique thread design for atraumatic placement and high primary stability.

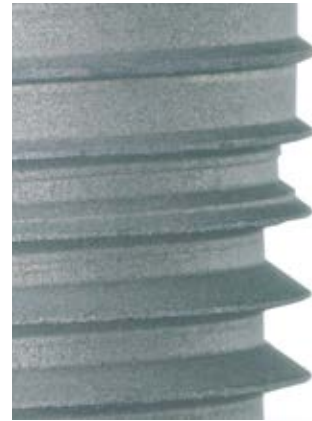

2 | (Micro)extended implant shoulder for a dense cervical contact between bone and implant.

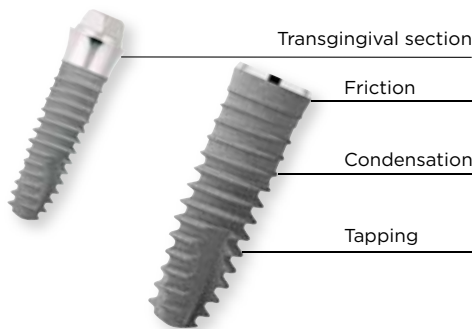

Xive S and Xive TG screw implants with self-cutting threads and core design for internal condensation.

Trimodal Xive® implant surface

A strong bone-implant interface shielded from damaging intraoral influences by a soft-tissue collar is essential for the long-term success rate of implants. The three-section hybrid surface of Xive implants with the Friadent plus surface in the endosseous section is the basis for optimum integration of the implant body.

Structure-polished implant collar

- Perfect soft-tissue adaptation with dense deposition of epithelium on the implant
- Protection of the underlying tissue from mechanical and microbial irritation

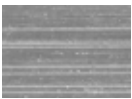

Acid-etched section

- Promotes deposition of subepithelial connective tissue
- Makes it easier to reach the planned implant position in uneven bone, because bone-forming cells and soft-tissue cells both form on the implant



Endosseous section with Friadent plus surface

- Favors stable adhesion of bone-forming cells
- Induces intensive bone formation from the earliest stages of osseo-integration
- Ensures high primary stability and allows early functional loading of implants

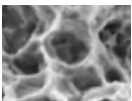

1 | Trimodal implant surface.

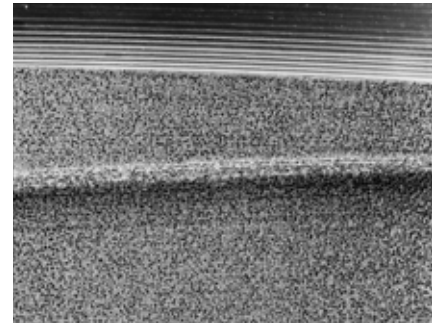

2 | Initial contact and anchorage of an osteoblast by thread-like extensions (filopodia) on the Friadent plus surface.

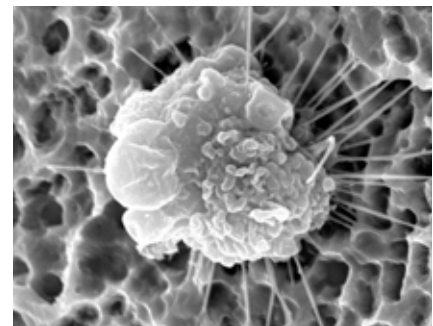

3 | Cells on the Friadent plus surface form typical, widespread multifocal contacts that are interconnected and extend the pores over long distances. The cell chains consist of three to six cells, each approx. 30 µm long.

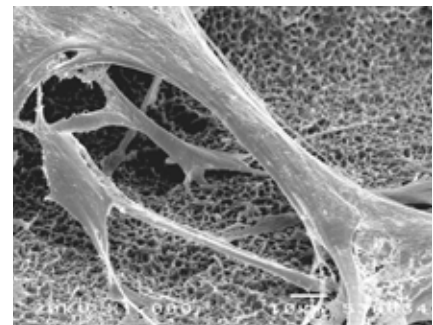

(fig. 2 and 3: R. Sammons et al.)

4 | Section of the thread of a Xive implant (20x magnification). Homogenous bone margin (red) between the implant threads.

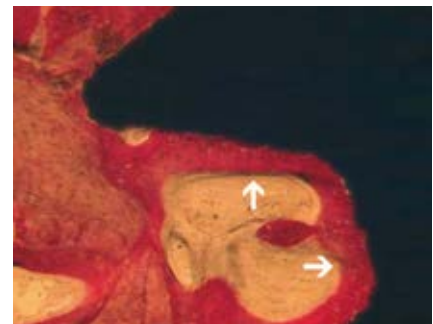

(fig. 4: Prof. Dr. A. Piattelli, Chieti/1.)

Comprehensive implant selection

Xive® implant-abutment connection

The deep, internal Xive S implant-abutment connection with internal hex locks the prosthetic components in the implant by transferring laterally acting forces directly from the internal geometry of the implant via the abutment.

Xive® S: deep, internal hexagonal connection

- Clear and accurate positioning of the abutment with six reversible positioning options
- Rotation lock by internal hex
- Stability with 3.5 mm deep parallel guide surfaces in the implant and wide plateau on the implant face
- Restoration with prosthetic components from the Friadent range of prosthetic components

The Friadent abutment screw locks the abutment in the implant and is not exposed to any horizontal stresses. This effectively prevents screws from loosening and breakage.

Xive® TG: extended implant neck with external square

- Clear and fast positioning of the abutment with eight positioning options
- One prosthetic diameter (D 3.8) for all implant diameters
- Restoration with prosthetic components from the Xive TG range of prosthetic components



Bone-specific preparation protocol

The bone quality in the maxilla and the mandible may vary greatly depending on the area of the jaw. By varying the preparation of the crestal section of the implant site depending on the bone quality in combination with the condensing implant design, Xive achieves excellent primary stability in all bone qualities – atraumatic and gentle in hard bone of density D I, stable and secure in soft bone of density D IV.

Bone-quality-oriented Xive® implant site preparation

Once the site has the required implant diameter, the next step is generally crestal preparation of the bone to adapt it to the clinical situation. Here the drilling depth of the crestal drill is varied depending on the bone density, and in harder bone quality the tap is also used. This preparation is always required unless there is no cortical bone. The preparation of the cavity to adapt it for the bone density ensures ideal conditions for not loading the cortical bone during placement of Xive screw implants.

Xive® condensing implant design

The special design of Xive implants condenses the peri-implant bone during implant placement in cancellous bone without requiring the assistance of additional instruments (see page 6). This principle of internal condensation achieves excellent primary stability and means that the implant is securely fixed even in very soft or reduced bone quality.

Atraumatic Xive® implant placement

Implant placement in cortical bone is safe and atraumatic with the apically self-tapping Xive thread. Tapping the crestal implant site during implant placement with this thread prevents stress and overheating, particularly in the physiologically less reactive cortical bone.

For detailed instructions on preparation of the implant site see page 19 ff.

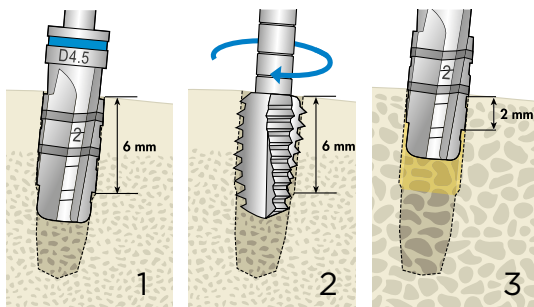

1 | The depth of crestal preparation in D I to D III bone is 6 mm.

2 | In particularly dense bone the tap is also used.

3 | The depth of crestal preparation in D IV bone is 2 mm.

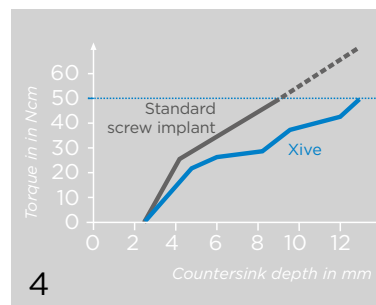

4 | Torque stabilization of Xive (blue) in bone quality D I; the platform formation guarantees an atraumatic placement.

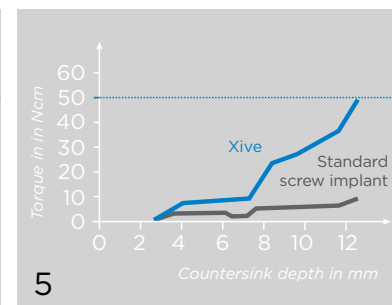

5 | Torque stabilization of Xive (blue) in bone quality D IV by internal condensation.

Prosthetic versatility

Friadent® TempBase concept

The unique TempBase concept for Xive allows immediate restoration with a high-quality temporary denture in many cases. Immediate loading of the implants is also possible under suitable conditions.

The multifunctional Friadent TempBase is premounted as an placement head on all Xive S implants. It is also designed to be used as a provisional abutment to which a temporary restoration can be attached without changing components - i.e. without additional risk.

With submerged healing

- Index impression with TempBase Cap immediately after implant surgery
- Manufacture of a high-quality, accurately fitted temporary denture in the laboratory for delivery immediately after implant uncover

With a single-stage procedure

- Fabrication of a high-quality implant-supported temporary denture with TempBase Cap in the chairside immediately after placement

For detailed instructions on the application of Friadent TempBase see page 42 ff.



1 | Insertion of the Xive implant with color-coded Friadent TempBase.



2 | The pre-fabricated Friadent TempBase Cap as the base for the temporary denture.



3 | Non-functional immediate loading with a temporary crown.

(Photos Jan Kielhorn, Öhringen/D)

Xive® prosthetic options

Friadent prosthetics have been setting new standards in the dental practice and dental laboratory for almost 20 years. The range is clearly classified and color-coded throughout. The patented, deep internal hex connection between implant and abutment enables a secure connection and minimizes micromovements between implant and abutment.

Xive® S prosthetic restoration

A wide range of prefabricated components for prosthetic restoration on Xive S implants in even the most demanding cases is available in the Friadent prosthetics range - in the implant diameters, various gingival heights, straight and angled.

Xive S	Single tooth-crowns	Fixed bridges	Removable denture
Friadent Esthetic Base	x	x	-
Friadent Cercon Abutment	x ¹	-	-
Friadent CeraBase	x ²	-	-
Friadent AuroBase	x	x	x
Friadent MP Abutments	-	x ²	x ²
Friadent Ball Attachment	-	-	x ^{2,3}
Friadent Telescopic Abutment	x	-	x
Xive TitaniumBase	x	-	-
Xive Locator	-	-	x

¹ Single-tooth restoration in front-tooth region only (region 13-23 and 33-43), available in D 3.8 and D 4.5 only.

² Not available for D 3.0.

³ In the edentulous mandible only on at least two implants interforaminally.

Xive® TG prosthetic restoration

Special Xive TG prosthetic components are available for prosthetic restoration of transgingival Xive TG implants. The prosthetic diameter is identical for all implant diameters.

Xive TG	Single tooth-crowns	Fixed bridges	Removable denture
Xive TG Abutment	x	x	-
Xive TG AuroBase	x	x	-
Xive TG Waxing Sleeve	-	x	-
Xive TG Bar Coping	-	-	x
Xive TG Ball Attachment	-	-	x ¹

¹ In the edentulous mandible only on at least two implants interforaminally.



Treatment planning

Aspects of treatment planning

The treatment planning is based on a comprehensive consultation with the patient, which is used to determine exactly what the patient wants and expects from the treatment, discover any possible contraindications and to explain the treatment in detail to the patient.

It is followed by a complete general and specific medical history and intraoral diagnosis with analysis of the initial anatomical situation.

The following points must be considered:

- Medical history
- General diagnosis – exclusion of contraindications
- Specialist consultation for risk factors
- Detailed intraoral diagnosis (PAR diagnosis, functional examination, reasons for tooth loss, evaluation of the old denture, general radiology examination)

The treatment plan can be prepared after examination and evaluation of all diagnostic documentation. The plan will include the following:

- Preprosthetic planning
- Surgical planning
- Schedule
- Cost schedule

Accurate planning of every implantological procedure is essential for the long-term success of implant treatment. The planning process defines all actions and lists alternatives that can meet the patient's expectations of the function and esthetics of the implant-prosthetic rehabilitation.

Indications for Xive® S and Xive® TG

Xive implants enable an excellent prosthetic restoration for all surgical indications. Xive implants are particularly good in situations as follows:

- Grafting not wanted or not indicated, e.g. atrophied alveolar ridge, multiple implant-borne restorations in posterior regions
- A cylindrical implant design offers advantages - particularly in the side tooth region
- Maximum use of the local bone is required: implant lengths 8 mm to 18 mm
- High primary stability is required for immediate function of implants
- Immediate implant placement or delayed immediate implant placement is planned

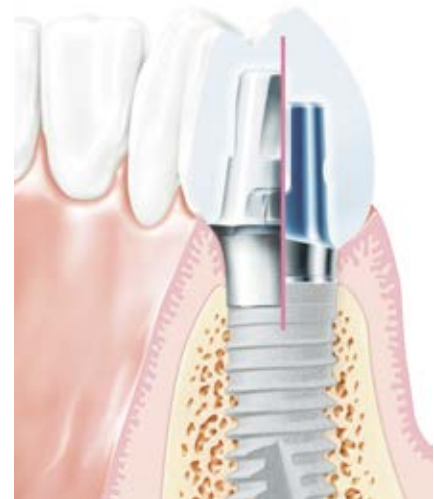

Indications specially for Xive® S

The two-component Xive S implants allow submerged healing or a single-session procedure, possibly with fabrication of a high-quality temporary denture with the Xive TempBase at the time of implant placement. Xive S is ideal in situations such as:

- Where the interalveolar volume is limited: smallest implant diameter D 3.0
- Temporary and definitive components are wanted for a simple and fast prosthetic restoration
- All prosthetic restoration options are to be left open
- Anatomically adapted diameters are to be selected



Single-tooth restoration in the mandible with a subgingival Xive S Implant.

Indications specially for Xive® TG

Xive TG is the single-component, transgingival option for situations such as:

- A single-component transgingival implant design is reasonable
- A single-stage implant-borne restoration is preferred
- Standard diameters can be selected

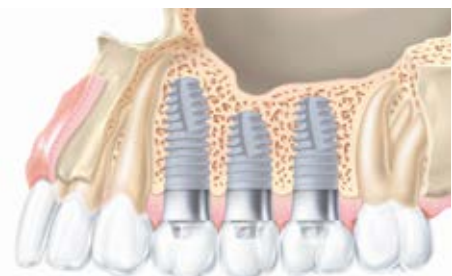

Transgingival maxillary restoration with Xive TG.

Conventional treatment planning

Preprosthetic planning

Preprosthetic planning with the dental technician is the most important factor for the esthetic and functional success of the implant procedure. The target is the best possible, tooth-analog placement of the implants.

During the first planning session with the patient situation impressions are made to be used as the base for laboratory-fabricated diagnostic aids.

A diagnostic wax-up of the planned prosthetic restoration is made.

A thermoformed splint with radiographic balls that can be accurately repositioned in the patient's mouth is prepared. It can be subsequently modified to a conventionally fabricated surgical template.

The preprosthetic planning is simplified with the Friadent Select components.



Diagnostic wax-up.



Thermoformed splint with radiographic balls.

Contraindications

The general contraindications for dental and surgical procedures must be taken into account when selecting patients. They include:

- Reduced blood clotting such as anticoagulant therapy, congenital or acquired clotting disorders
- Problems with wound healing or bone regeneration such as uncontrolled diabetes mellitus, tobacco, drug and alcohol abuse, metabolic diseases that could affect wound healing and bone regeneration
- Immunosuppressive therapy such as chemotherapy and radiotherapy
- Infections and inflammations in the oral cavity such as periodontitis, gingivitis

- Untreated parafunctional disorders such as bruxism
- Poor oral hygiene
- Lack of motivation for total oral rehabilitation
- Poor occlusion and/or articulation and inadequate interocclusal distance
- Insufficient bone volume or soft tissue coverage

Side effects

The following side effects of surgical procedures may include:

- Temporary local swelling, edema, hematoma
- Temporary restriction of sensitivity and chewing function

Friadent® Select try-in abutments

Friadent Select try-in abutments make selection of the optimum implant diameter much easier. Because the dimensions of the try-in abutments match those of the subsequent crown abutments, the oro-vestibular and the mesiodistal position and the distance to adjacent implants or teeth can be measured on the planning model and checked during surgery after the pilot hole has been drilled and modified if necessary. Friadent Select try-in abutments can also be used with the Xive S implant and the associated implant analog.

Friadent Select try-in abutments:

- Available in diameters D 3.0 - D 5.5 in straight form
- Also available in angled form (D 3.0 to D 3.8) for checking angulation
- Step marks corresponding to gingival margins GH 1, GH 2, GH 3
- Groove marks for total occlusal height
- Drilled holes matching GH 2 for determining the position of the horizontal retaining screw
- Determines the implant position and the position of the horizontal implant clearance
- Checks the oro-vestibular and the mesio-distal position
- Determines the gingival margin and the position of the horizontal screw

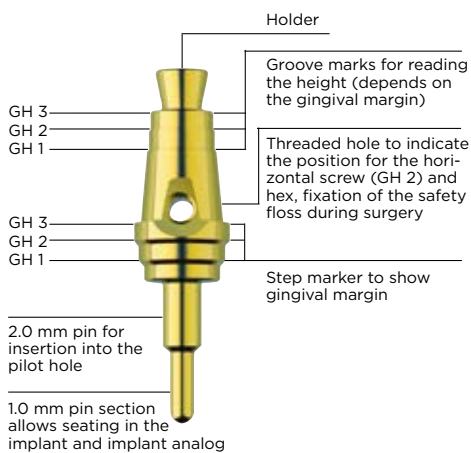
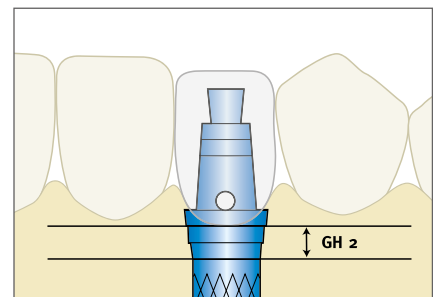
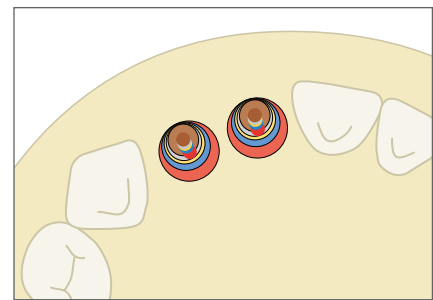

Conventional treatment planning

Surgical planning

During preoperative planning it is very important to check that the height and width of the jawbone is sufficient for placement of the implant.

Fabrication of the surgical template

The surgical template, which is used to transfer the pre-prosthetic planning to the clinical situation, is fabricated on completion of the surgical and prosthetic treatment planning. The correct seating of the surgical template must be checked in the oral cavity.

The width of the vestibular and oral lamellae should be at least 1.5 mm. The position and direction of important anatomical structures such as the mental foramen or maxillary sinus must be determined by radiology. Grafted regions must be confirmed to have completely regenerated to a mechanically stable state before preparation.

Planned prosthetic measures must be checked to ensure that they can actually be implemented with reasonable surgical procedures. All aspects of preprosthetic and surgical planning interact directly with one another. Every change in the preprosthetic planning will affect the surgical planning and vice versa.

This will also include the number, diameter, lengths, position and alignment of the implants.

The available bone volume and important anatomical structures are examined in an radiographic image, which is prepared with the laboratory-fabricated radiographic template with the radiographic balls in the patient's mouth. The dimensions inside the oral cavity can be calculated accurately from the defined diameter of the radiographic balls.

The implant lengths are selected by placing the transparent Xive x-ray template on the OPG.

Friadent® Select sleeves

The Friadent Select sleeves, which are integrated in the surgical template, are used to transfer the preprosthetic planning exactly to the clinical situation. The sleeve that corresponds to the implant diameter indicates the implant center, the Friadent Select guide pin, which is fixed in the central internal hole, shows the direction of the implant hole. The crestal implant center is marked with the D 2.0 twist drill during the pilot drilling.

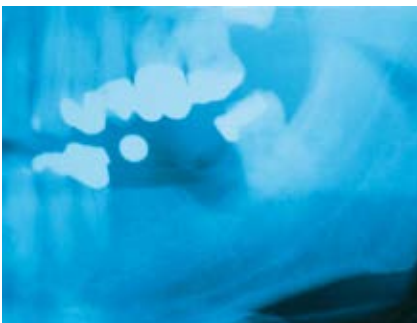
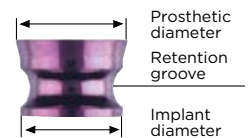

Xive radiographic template.

Computer-guided treatment planning

Digital treatment planning based on three-dimensional imaging procedures enables the therapy to be planned with absolute accuracy and makes the result of the treatment exactly predictable.

Guided Surgery from Dentsply Sirona Implants offers a complete solution for digital treatment planning and template-guided implant placement based on the Simplant software, which is used all over the world.

The advantages over conventional planning include:

- Safe three-dimensional planning in the submillimeter range and with reference to the desired restoration
- Automatic collision control, which indicates inadequate clearances between implants or to the nerve (inferior alveolar nerve)
- Information on peri-implant bone quality for accurate conclusions on the probable primary stability

A custom-made Simplant SAFE Guide is fabricated by stereolithography using the digital planning data. This guarantees that the planning will be fully and accurately transferred to the patient's mouth with the highest degree of convenience, even in the posterior region, thanks to the unique lateral drill guide access.

Drills with a guide sleeve attached to the instrument, which have been specially developed for template-guided implant placement with Simplant using accurate guides in the template (Sleeve-on-Drill system), enable exact transfer of the planned implant position and secure placement of the implants.

For detailed information on surgical procedure see page 67.

Digital treatment planning with Simplant.

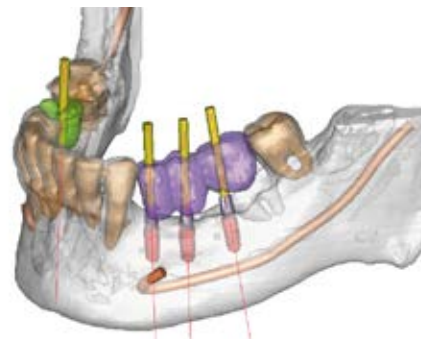

Patient-specific Simplant SAFE Guide with laterally accessible sleeves.



Sleeve-on-Drill system.



Implant site preparation

Xive® surgical kits

All instruments for surgical use of the Xive implant system are stored in Xive surgical kits, which are designed to make all instruments easily accessible and easy to clean and sterilize. The modular components of the trays with the minimum required number of instruments can be supplemented with additional modules for specific diameters.

The light plastic trays with organizers integrated into the cover for holding used instruments define a specific user sequence during surgery. All instruments are securely held in silicone holders.

The Xive surgical manual describes the standard protocol for implant site preparation with Xive twist drills. If you have decided to use computer-guided treatment planning and preparation, please see page 73. From the chapter "Implant placement and restoration" (see page 40 ff.) the procedures and options for both protocols are similar.





Practical organizer
for used instruments

Removable tray cover
for simple handling
during surgery

Storage of implant drills in
diameter-specific snap-on
modules for utmost flexibility

Surgical ratchet,
implant drivers and
screw drivers clearly
arranged

Base plate for stable fixation
of the modules

The following Xive surgical kits
are available:

**Xive Surgical Kit
D 3.0 - D 5.5 / S+L:**

Fully equipped with all instruments
required for placement of Xive
implants in diameters of 3.0 -
5.5 mm, including two lengths of
twist drills, S (short) and L (long).

**Xive Surgical Kit
D 3.0 - D 3.8 / S:**

Basic kit with all instruments and
S (short) twist drills required for
placement of Xive implant in
diameters of 3.0 - 3.8 mm.

For preparation with Guided
Surgery a separate surgical kit is
available.

**Xive Surgical Kit
D 3.0 / S+L:**

Equipped with all instruments re-
quired for placement of Xive D 3.0
implants including two lengths of
twist drills, S (short) and L (long).

**Xive Surgical Kit GS
(Guided Surgery)**

Includes all instruments required
for computer-aided placement
of Xive implants D 3.0 - D 4.5 of
lengths L 8 - L 15.

The trays can be thoroughly and
easily cleaned in accordance with
ISO 17664 - please follow the
instructions in the Cleaning, Care
and Sterilization Manual.

Washtray

The washtray allows for machine cleaning, disinfection and subsequent steam sterilization of instruments. It is one tray for all steps of reprocessing, this enhances time- and cost-efficiency. The instruments are fixed and organized from chairside through all steps of reprocessing and back to chairside. The removable overlay has a layout very similar to the existing plastic surgical kits which offers easy orientation and intuitive handling during surgery

The sterilization container for simple, quick and safe handling can be ordered separately

Cleaning and sterilization

The overlay must be separated from the washtray before cleaning and re-assembled prior sterilization. Please note "Dentsply Sirona Implants Instruction for Sterilization and Instrument Care" are need to be considered before use.

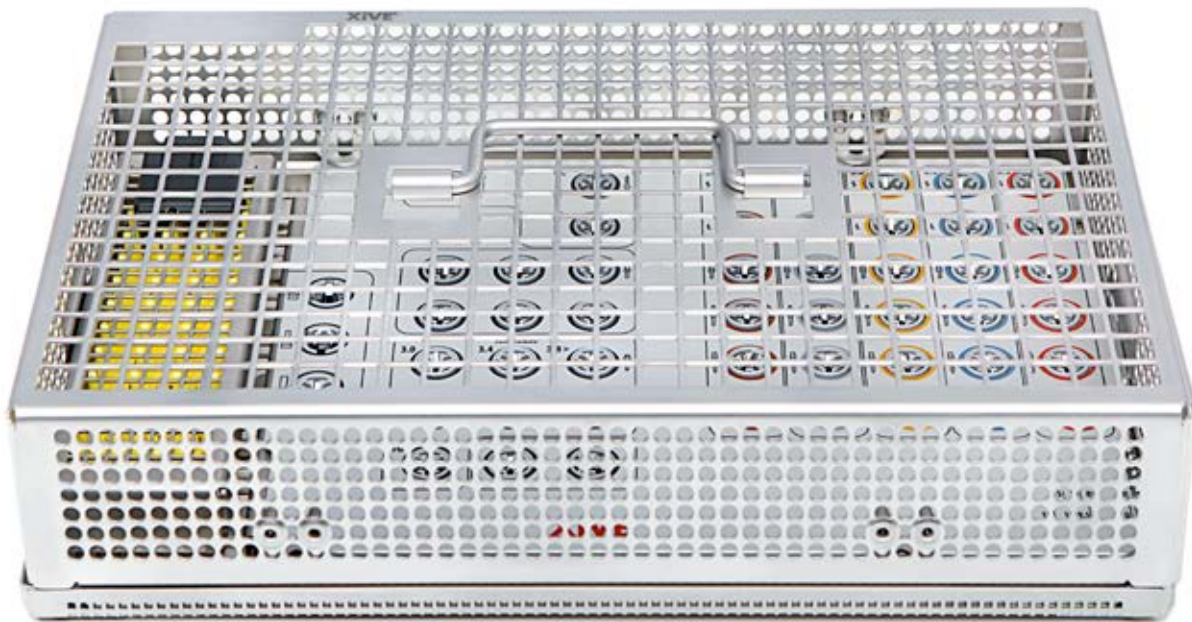

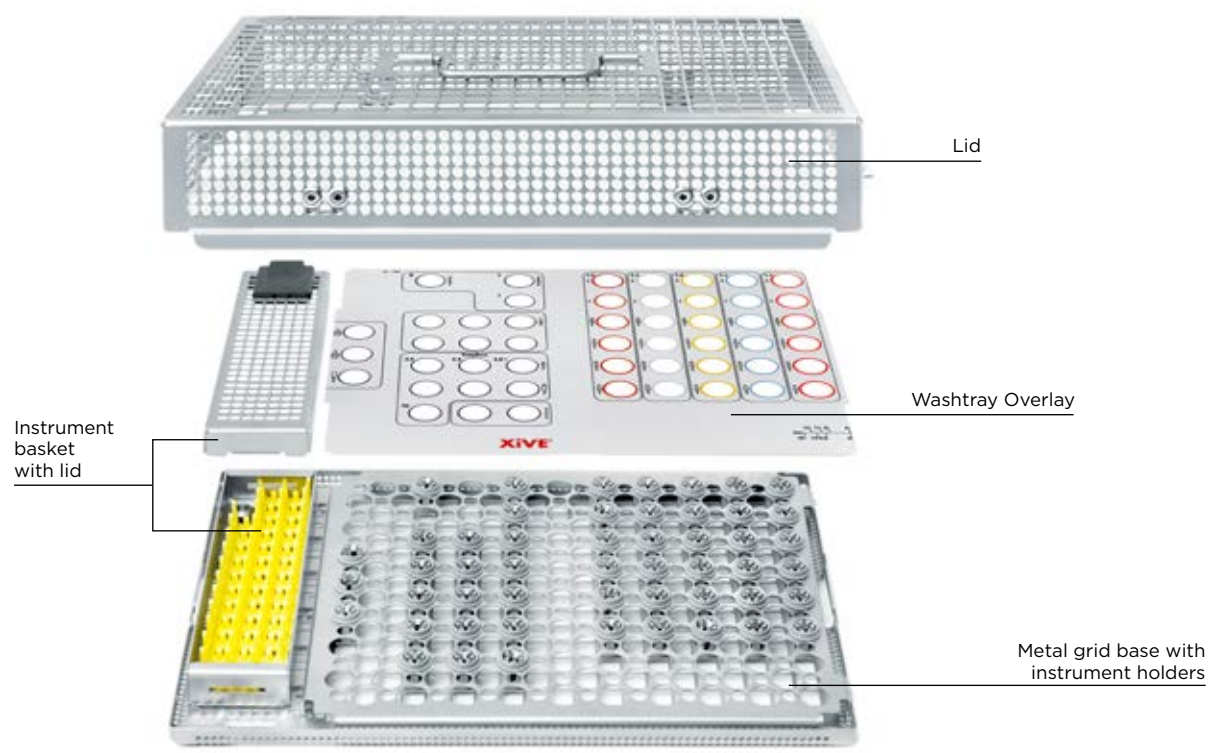

Xive® instrument set

An essential component of a successful implant placement is accurate and atraumatic preparation of the bone at the implant site. The implant site is prepared for Xive implants in accordance with the bone class to ensure simple and safe implant placement in all bone qualities.

The instrument set for implant site preparation is identical for Xive S and Xive TG implants.

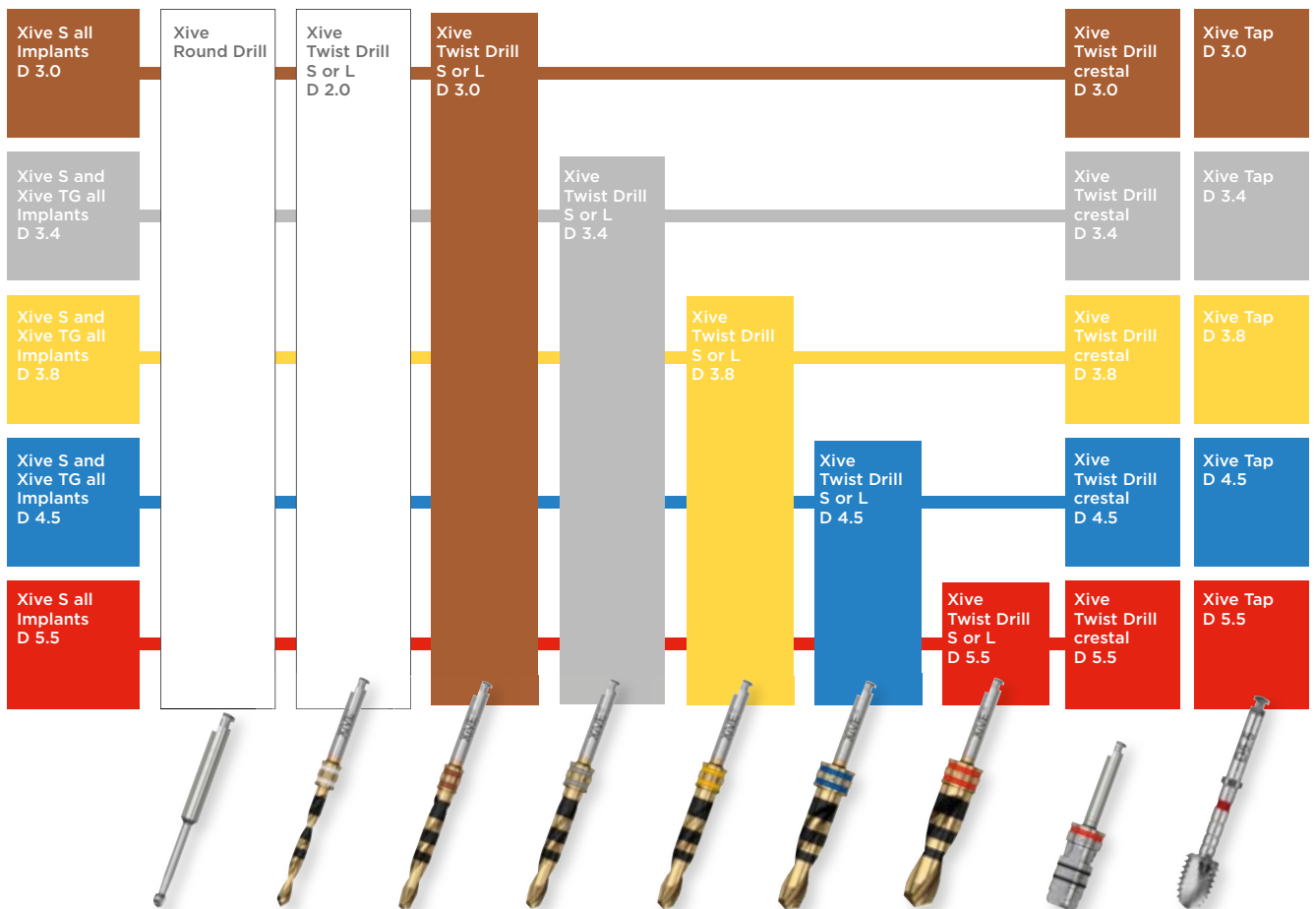

Cutting instruments should generally be replaced after 10 cycles of use. Blunt or damaged instruments must be replaced immediately. Gentle, thorough disinfection and cleaning of the drills will ensure that they operate at their best. Please observe the instructions in the cleaning manual.

Xive® Twist Drill S (short) and L (long)

The implant site is prepared atraumatically and accurately to the required implant diameter with Xive twist drills.

Twist Drill	S	L
D 2.0	L 8 - L 15	L 8 - L 18
D 3.0	L 8 - L 15	L 8 - L 18
D 3.4	L 8 - L 15	L 8 - L 18
D 3.8	L 8 - L 15	L 8 - L 18
D 4.5	L 8 - L 15	L 8 - L 18
D 5.5	L 8 - L 15	L 8 - L 18

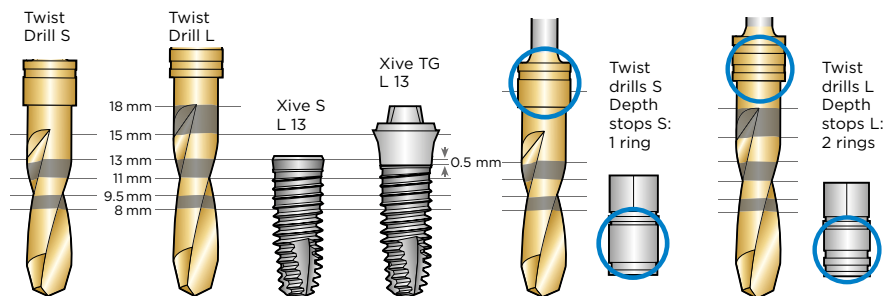

Xive twist drills for multiple use are available in two lengths:

- **Xive twist drill S** (short) for easy handling, e.g. in the posterior region
- **Xive twist drill L** (long) for the anterior region and for the maximum implant length of 18 mm

Color-coded rings make it easy to distinguish the two lengths:

- 1 ring: twist drill S
- 2 rings: twist drill L

Markers to indicate the available implant lengths are etched at the working tip of the drills to indicate the insertion depth. Combined groove and laser markers (zebra design) make it easy to read the markers during surgery.

Additional properties of Xive twist drills:

- Two-edged profile of surgical stainless steel
- Standard ISO shaft connection for contra-angle handpieces
- Color-coding and length markers for all drills and depth stops
- Sterilizable
- Removable depth stops (optional)

Xive single-patient drill

Xive twist drills in the S length (for implant lengths up to 15 mm) in diameters D 2.0 - D 5.5 are also available for single use. These drills with a color-coded, plastic-sheathed shaft are supplied in

sterile condition. They cannot be re-sterilized. Using a disposable drill ensures optimum preparation of the implant site because of the high cutting performance of the drill.



Xive® instrument set

Xive® depth stops

Xive depth stops for Xive twist drills (multiple use) make safe implant site preparation to the planned depth even easier.



Xive depth stops for Xive twist drill L of diameter D 3.4/3.8 for implant lengths L 8/L 9.5/L 11/L 13/L 15 and L 18 (left to right)

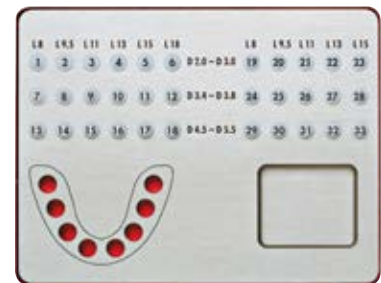

They can be mounted quickly and easily without additional instruments simply by sliding the depth stop over the tip of the drill. The colored rings indicate the direction of the drill shaft. The depth stops can be removed manually. One depth stop is available for two diameters.

The color-coding on the depth stops indicates the drill diameters for which the depth stop is designed:

- D 2.0 and D 3.0 (white / bronze)
- D 3.4 and D 3.8 (silver / yellow)
- D 4.5 and D 5.5 (blue / red)

All Xive depth stops are available for S twist drills or L twist drills. Like the drills they have one (S) or two (L) rings.

Xive SecurityKit

Xive depth stops for both lengths of drill and all implant lengths are logically arranged in the sterilizable aluminum Xive SecurityKit. The Xive SecurityKit is available as a StandardSet (for S twist drill only) and as an ExpertSet (for S and L twist drills).

The depth stop may prevent the drill from fully reaching the planned depth if it is used on uneven bone. In such cases the depth stop should be removed and the depth measured with the laser marker on the drill.

Implant site preparation in accordance with the bone quality

The bone quality in the maxilla and the mandible may vary greatly depending on the area of the jaw. The density of the cancellous bone is shown clinically by the pilot hole. It can also frequently be estimated radiologically from the orthopantomogram (OPG) and on the single image. The computer-guided treatment planning can also show information on the bone quality that can be estimated. The preparation technique must take the local bone quality into account to ensure the primary stability of the implants.

According to Misch et al.¹ and Lekholm and Zarb², bone of various qualities can be classified into four classes D I - D IV.

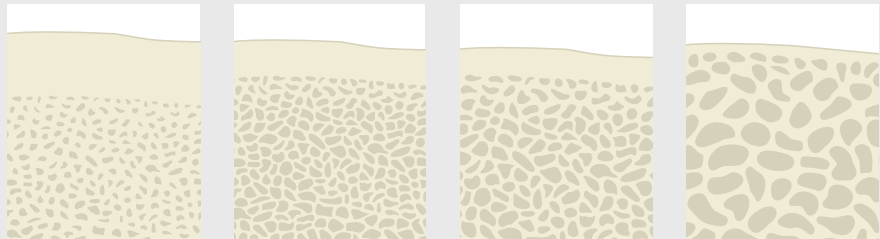

Bone class D I
Dense cortical bone,
little spongy bone.

Bone class D II
Dense cortical bone,
large-grain
spongy bone.

Bone class D III
Thin cortical bone,
fine-meshed
spongy bone.

Bone class D IV
No cortical bone,
fine spongy bone.

Localization of different bone densities

- In the frontal region of the mandible: mostly very hard cortical bone (D I)
- In the side tooth region of the maxilla: soft cancellous bone (D IV)

Superior primary stability in every bone quality

By varying the preparation of the crestal section of the implant site depending on the bone quality in combination with the condensing implant design, Xive achieves excellent primary stability in all bone qualities – atraumatic and gentle in hard bone of density D I, stable and secure in soft bone of density D IV.

Bibliography:

1 Misch CE: *Density of bone: Effect on treatment plans, surgical approach, healing, and progressive bone loading*. *Int J Oral Implantol* 1990; 6 (2): 23-31

2 Lekholm U, Zarb GA: *Patient selection and preparation*. In: *Branemark PI, Zarb GA, Albrektsson T (eds): Tissue-integrated prostheses. Osseointegration in clinical dentistry*. Quintessence, Chicago 1985: 199-209

Xive® instrument set

Xive® Twist Drill crestal

The next step after implant site preparation with the S or L twist drill is crestal preparation of the bone in accordance with the bone quality to adapt it to the

clinical situation. The Xive surgical kit includes a color-coded crestal twist drill for every implant diameter.

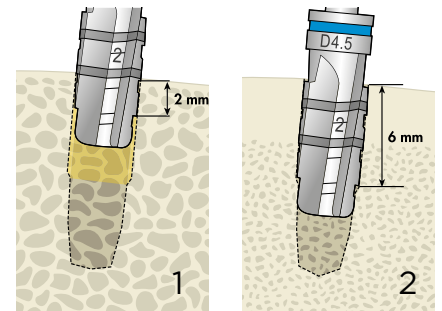

The working tip of the drill is designed to match the implants. The micro-extension of the implant neck is also taken into account. The extension is transferred to the implant site when the insertion depth is extended as far as possible. The variable preparation depth of the crestal region of the cavity controls the degree of internal condensation that is achieved with the special Xive implant and thread design during the final placement.

Additional properties of the Xive crestal twist drills:

- Manufactured from surgical stainless steel
- Cutting edge length maximum 6 mm
- Non-cutting apical step 2 mm long to guide the drill in previously prepared bone
- Expansion of diameter in the crestal section of the cavity by approx. 0.2 mm

If there is no resistance or only minimum resistance during standard preparation a low bone density can be assumed. This is taken into account subsequently when using the Xive crestal twist drill: the preparation depth in this case is 2 mm to reduce the preparation solely to the crestal section of the bone (fig. 1).

High resistance of the bone during preparation indicates bone class D I. In this case the bone is prepared to the maximum depth of 6 mm (fig. 2).

The maximum depth for crestal preparation of the cavity for implants 8 mm long is 4 mm.

More information about different bone densities/bone classes, please see p. 25.

The Xive crestal twist drill should generally be the last drill used for preparation. In very strong bone the tap must be used after the Xive crestal twist drill (6 mm deep) has been used to the maximum possible depth (see p. 34).

Useful information

Excessive torques that may occur during implant placement traumatize the peri-implant bone and endanger osseointegration. Observe the recommendations for correct use of the Xive crestal twist drill for maximum benefit from the special thread design without running the risk of damaging the bone.

Depending on the bone quality the insertion depth of the Xive crestal twist drill may vary between 2 and 6 mm (see pages 26 and 34).

It may not always be possible to define the bone class definitively even after use of the Xive twist drills. Maximum benefit from the condensation effect resulting from the thread design is desirable, particularly in cancellous bone. In contrast, in more compact bone it is not necessary to assist primary stability with internal condensation. The effect of internal condensation is controlled by the insertion depth of the crestal twist drill. Very high torque forces may be encountered, particularly during implant placement in the mandible, because of the high proportion of cortical bone. The macrodesign of Xive implants is intended to achieve a high primary stability with the special core and thread shape. Sufficient primary stability can be achieved even in hard bone at the maximum insertion depth of 6 mm of the Xive twist drill crestal.

The Xive tap must also be used in dense cortical bone (D I) to limit the torques encountered during insertion to physiological values.

Xive® Tap

After crestal preparation with the Xive crestal twist drill the thread for the implant is tapped in the crestal section of the implant site in cortical bone of class D I with the Xive tap.

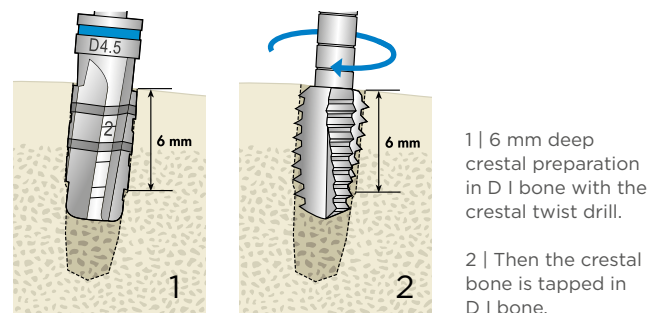

The Xive surgical kits includes a color-coded tap for every implant diameter which can be used with a contra-angle handpiece as well as with the Xive ratchet with 15 rpm. The taps are provided with hexagon on shaft for use with Frios contra-angle handpieces with hexagonal clamping system. This guarantees trouble-free thread-cutting even in very hard bone. The taps are compatible with all other contra-angle handpieces.



Xive[®] instrument set

Friadent[®] Select

Friadent Select components are used for both pre-prosthetic planning and monitoring during surgery. They can greatly improve the accuracy of the transfer of the planning to the clinical situation and the indivi-

dual preparation stages. The Friadent Select try-in abutments and try-in implants used during the surgical procedure are included with the Xive surgical kits. All components are fully color-coded.

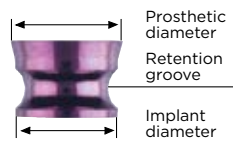
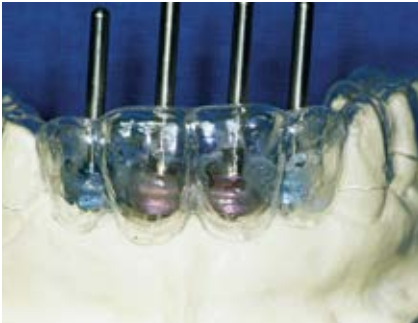

Friadent Select sleeves

Friadent Select sleeves are used for accurate transfer of the pre-prosthetic model to the clinical situation. The crestal center of the implant can be marked during pilot drilling with the central internal hole for the D 2.0 twist drill or the Friadent Select guide pin.

Friadent Select try-in abutments

Friadent Select try-in abutments simplify selection of the optimum implant diameter during surgery. They can be used with the Xive S implant and also with the implant analog.

Because the dimensions of the try-in abutments correspond to the sub-subsequent prosthetic abutments, they can be used to check the oro-vestibular and the mesio-distal position and also the distance to neighboring implants or teeth after the pilot drilling and if necessary they can be changed.

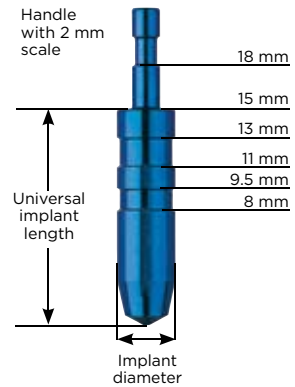
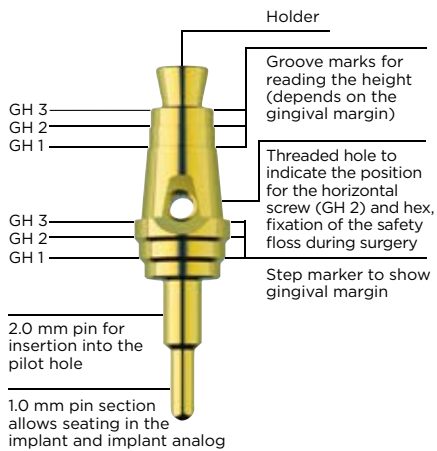

Xive Select try-in implants

- Available in diameters D 3.0 - D 5.5 in straight form
- Also available in angled form (D 3.0 to D 3.8) for checking angulation
- Step marks corresponding to gingival margins GH 1, GH 2, GH 3
- Groove marks for total occlusal height
- Drilled holes matching GH 2 for determining the position of the horizontal retaining screw

Xive Select try-in implants make in-process control during preparation of the implant site quick and easy. During the operation they are used to check the insertion depth and the crestal congruence of the bone cavity with the planned diameter.

- Design matches that of the Xive implant
- Available in the five diameters D 3.0 - D 5.5
- Can be used for all implant lengths
- Measure the thickness of the soft tissue with the seven millimeter long handle with 2 mm graduations

Step-by-step: Preparation with twist drills

The implant site preparation shown on the following pages is for a late implant placement, i.e. for a Xive D 4.5 / L 15 implant after consolidation of the bone of the alveolar cavity.

Where space is restricted a smaller implant diameter should be preferred. The special implant design also enables high primary stability and even distribution of forces. These characteristics protect important neighboring anatomical structures. During the planning phase it is important to check that the horizontal and vertical bone volume is sufficient for placement of an implant. The design of the Xive implants often makes it possible to place an adequately dimensioned implant even with reduced bone volume.

If the clinical situation is such that this is not possible, suitable augmentation procedures will be required.

Cutting instruments should generally be replaced after 10 cycles of use. Blunt or damaged instruments must be replaced immediately. Gentle, thorough disinfection and cleaning of the drills will ensure that they operate at their best. Please observe the instructions in the cleaning manual.

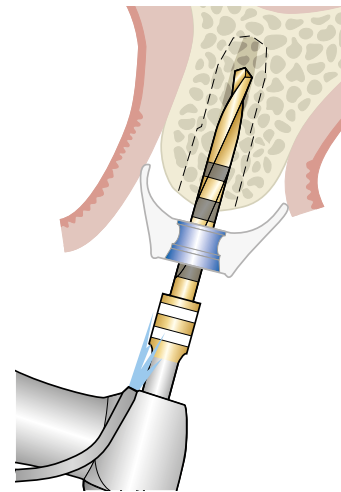
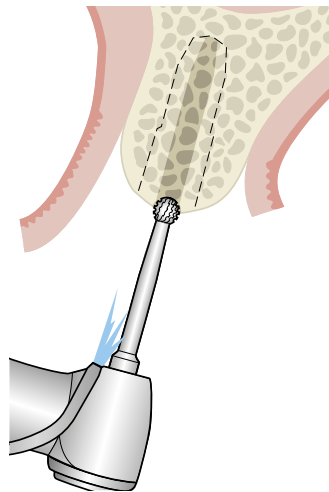
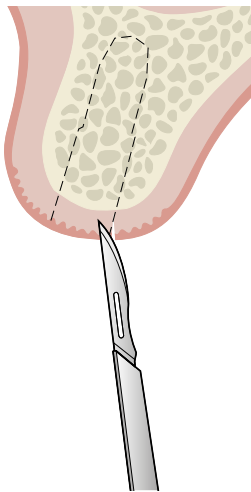

Incision direction

The bone is uncovered during the late implant placement by a (paracrestal) incision. The mucosa and periosteum are mobilized and folded back.

Marking

To give the next larger drill a secure hold, the cortical bone is beveled with the round drill. If a surgical template is not used, this drill can also be used before drilling the pilot hole.

Transfer of planning

The surgical template with Friadent Select sleeves is used to transfer the preprosthetic planning accurately to the clinical situation.

Pilot drilling

The pilot hole is drilled with the Xive D 2.0 twist drill. The central guide channel of the Friadent sleeve indicates the position and the direction.

Xive Twist Drills are used up to max. 1500 rpm.

Step-by-step: Preparation with twist drills

Implant site preparation for Xive implant D 4.5 / L 15.

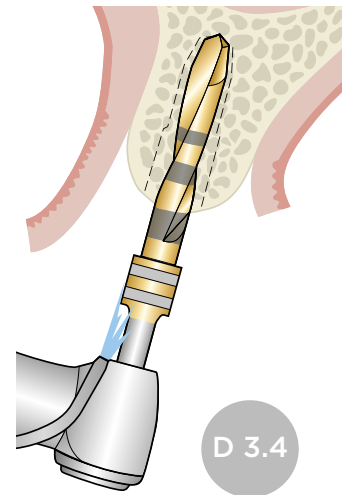
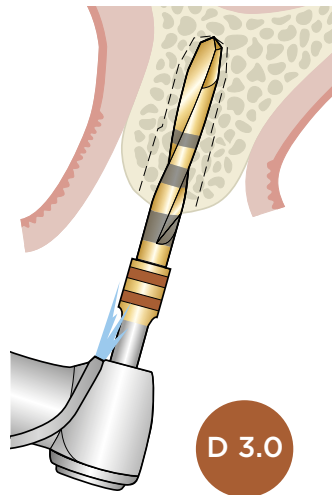
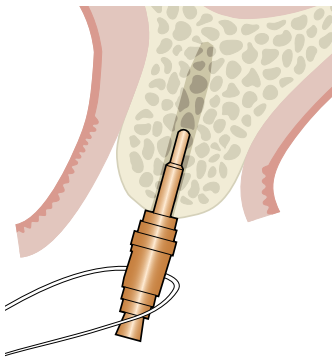

Checking the implant position

The Friadent Select try-in abutments can be used to check the position and distance to neighboring teeth and implants while pilot drilling.

Expansion drilling and final drilling D 3.0

The first expansion is drilled with the D 3.0 twist drill. If implants of diameter D 3.0 are being placed this will be the final drilling. The planned implant length and the region of the implant will decide the selection of the drill length (S or L).

Expansion drilling for D 3.4 - D 4.5

After pilot drilling the D 3.4; D 3.8; D 4.5 and D 5.5 twist drills are used in ascending order until the implant site is prepared to the planned diameter.

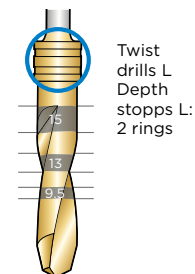
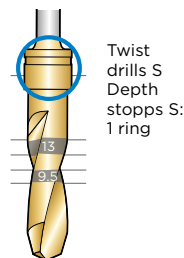

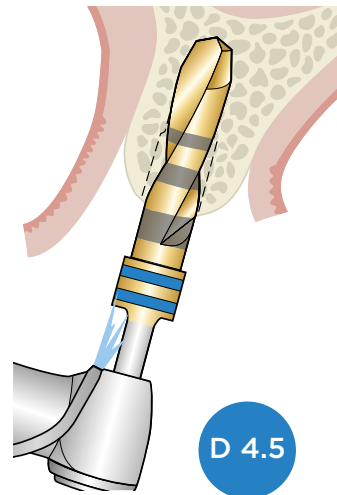
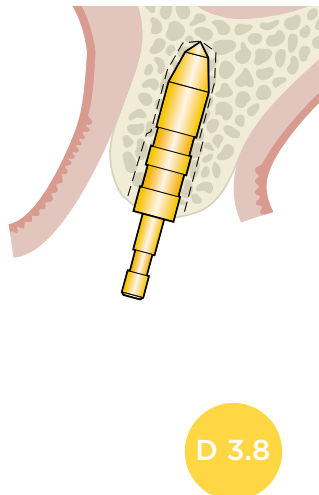
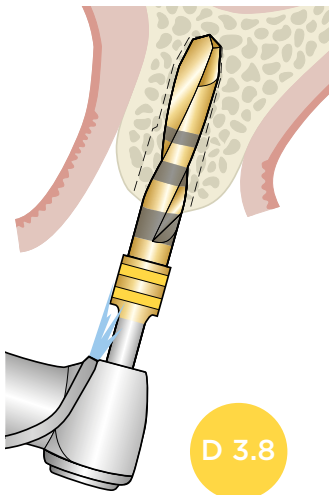

In-process control

The Xive Select try-in implants can be used to check the insertion depth and the crestal congruence of the bone cavity with the planned implant diameter. The hole may need to be adjusted. If the bone is not even, the depth stop may prevent the desired insertion depth from being reached. In such cases the depth stop should be removed and the preparation depth measured with the laser marker on the drill.

Final drilling

The final drilling uses the twist drill that matches the diameter of the planned implant. The Xive Select try-in implants can be used again to check the fit.

Step-by-step: Preparation with twist drills

Implant site preparation for Xive implant D 4.5 / L 15.

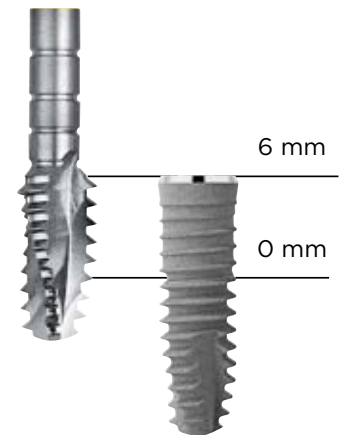
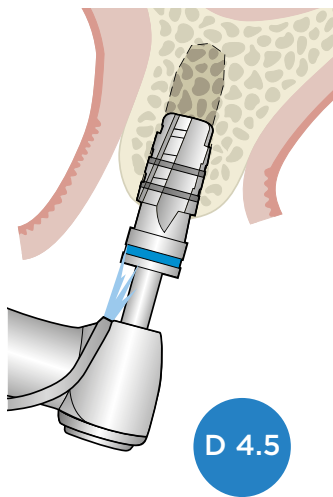

Crestal preparation of the bone

After the final drilling the cavity is prepared with the crestal twist drill as required by the clinical situation and the bone class. The instrument that matches the implant diameter is inserted to the depth corresponding to the bone density.

In cancellous bone (D IV):

If a cortical layer is present, the cavity should be extended 2 mm deeper.

In dense bone (D I to III):

Maximum extension of the working length of 6 mm will reduce the internal condensation to just the right extent while the implant is being screwed in subsequently.

Optional tapping in highly cortical bone

Crestal tapping is particularly important in the mandibular symphysis region to restrict the insertion torque to physiological values. The Xive tap can be used with the ratchet or the contra-angle handpiece.

The Xive crestal twist drill is generally required for vertical extension of the crestal implant site. Even at its maximum extension an excellent primary stability encourages healing. It is not used if there is no cortical bone.

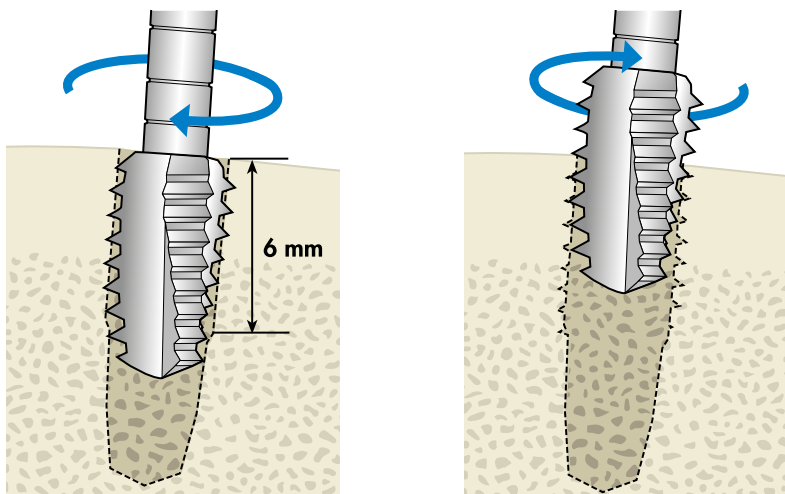

Tapping

The site is prepared with the Xive tap at the planned implant diameter at a maximum 15 rpm until the head of the instrument with the thread is no longer visible (6 mm depth).

When using the tap with the Xive ratchet use the Xive ratchet insert for instruments that can take the ISO connector of the tap.

Then the tap is turned counter-clockwise to remove it from the cavity.

Placement of more than one implant

If the plan includes restoration with more than one implant in one quadrant or jaw, the above protocol must also be followed. The use of a surgical template is particularly important in this case.

The axial alignment should also be checked during the operation. This requires first drilling all pilot holes and then inserting a parallel gauge or a Friadent Select try-in abutment into the cavity.

A reversed Xive Select try-in implant can also be used. It can be placed later as a standard implant to check the advanced preparation. The friction of a normally placed Xive Select try-in implant can be used to assist in deciding the insertion depth of the final crestal drill.

Xive® instrument set

Xive® BoneCondenser

Bone condensation can be used to optimize the clinical situation and therefore the conditions for the implant placement. The special design condenses the bone to improve the bone quality by implant placement alone.

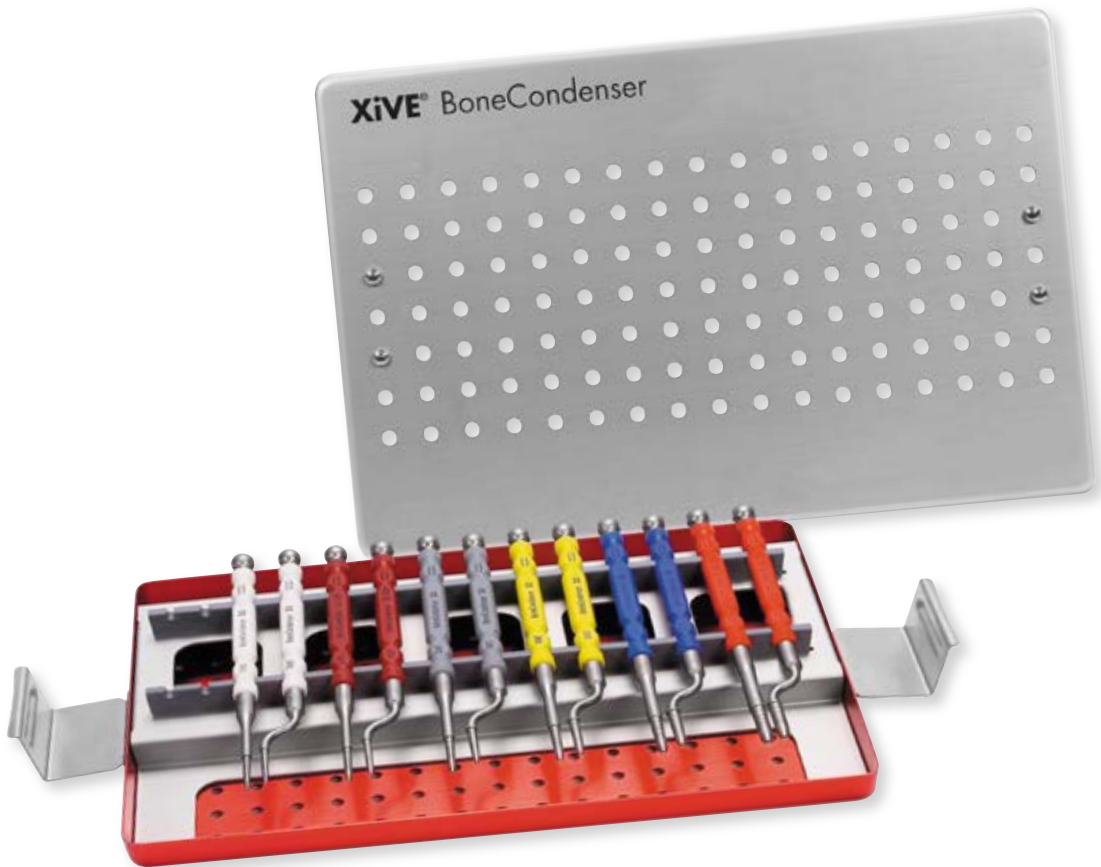



The cutting, concave working tip of the Xive BoneCondenser is used to initiate a controlled microfracture, which initially lifts the sinus floor locally and as a result increases the vertical bone volume.

Xive BoneCondensers are used

- **for reduced bone quality:** preparation of the implant site by condensation instead of ablation
- **for lack of bone height:** local lifting of the sinus floor to allow placement of longer implants

Xive BoneCondenser

- Manufactured from surgical stainless steel
- Color-coded, ergonomical and antislip molded handle of sterilizable plastic
- Design of the working tips similar to that of the Xive implant
- Markings for identification of lengths similar to the drills (8 mm, 9.5 mm, 11 mm, 13 mm, 15 mm, 18 mm)
- Cutting working tip (concave)
- Marking of D 2.0 and D 3.0 pilot instruments for use in the sinus region
- (2 mm and 4 mm)
- Universally applicable for all lengths
- Xive BoneCondenser set: 12 instruments in a sterilizable tray (one straight and one angled instrument per diameter)

Immediate function of implants is not indicated when using non-ablative preparation methods or major augmentation procedures.

Step-by-step: Sinus floor elevation with Xive® BoneCondensers

The Xive BoneCondenser requires adequate vertical and horizontal bone volume (approx. 8 mm). If the residual bone height is lower, an external sinus floor elevation with simultaneous or two-stage implant placement is indicated.

If the vertical bone volume is 8 mm the implant site can be expanded to a total of 12 mm with an internal sinus lift.

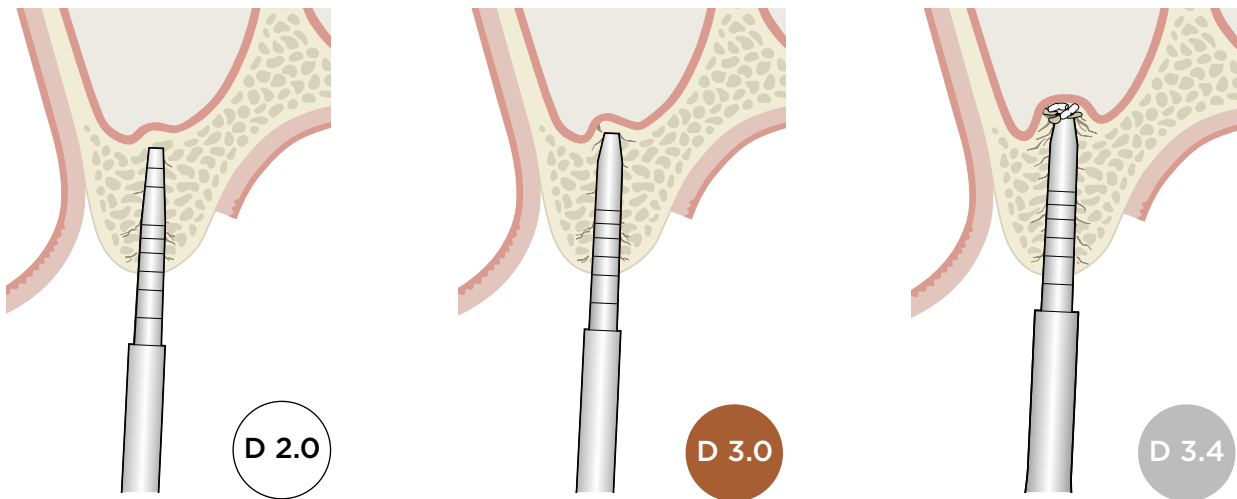

Osteotomy

Non-ablative preparation (osteotomy) with Xive BoneCondensers starts with D 2.0 in ascending order to the planned implant diameter (Summers technique).

The concave working tip also makes it easy to apply bone replacement material.

This reduces the risk of perforating the nasal mucosa.

Cutting instruments should generally be replaced after 10 cycles of use. Blunt or damaged instruments must be replaced immediately. Gentle, thorough disinfection and cleaning of the Xive BoneCondenser will ensure that it operates at its best. For cleaning and sterilization follow the instructions in the manual or cleaning manual. Immediate function of implants is not indicated when using non-ablative preparation methods or major augmentation procedures. This technique should not be carried out on patients until the implantologist has attended a relevant continuing education course.

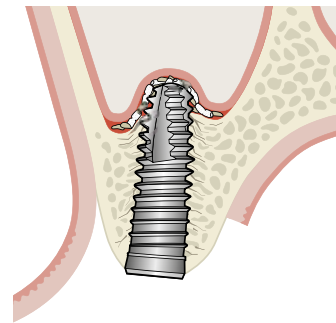
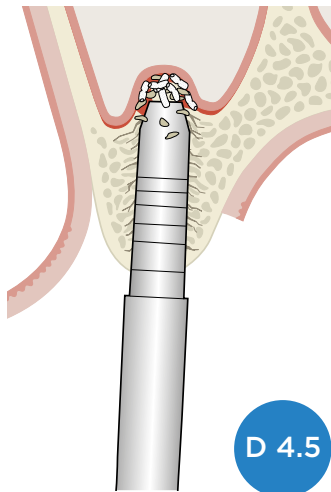
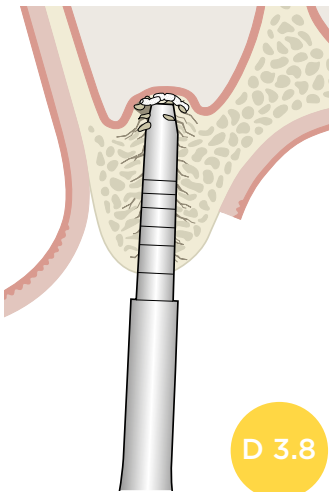

Possible complications

Perforation is always possible when lifting the nasal mucosa. Depending on the size of the perforation it may be necessary to cover it with a membrane. This requires a facial sinus window. The complications must be explained to the patient after

surgery. As with an oral-anthro connection after tooth extraction, it is recommended that the patient should not blow the nose for about two weeks and nose drops should be used as required. Additional complications may include suborbital hematoma and

concussion, all of which must be explained to the patient in detail before surgery.

Implant placement & restoration

Implant packaging

Xive S implants are supplied in a double-sterile blister package with an outer carton. The type of package offers the maximum product safety in conformance with the increasingly rigid requirements for medical devices. The packaging also makes it easy to store all products for quick retrieval and they are easy to handle during the surgical procedure.



Outer box package

- Simple product classification with brandspecific design, sight window and color-coded imprint of the implant diameter
- Large seal label with details of products
- Stackable, all important product information remains visible
- Includes multilingual instructions for use

Transparent outer blister

- Outer sterile barrier of implant package

Transparent inner blister

- Inner sterile package
- Contains implant shuttle with implant and cover screw for implants
- Peel-off label with batch code for reliable documentation of treatment



Plastic implant shuttle

- Holds the implant securely in the packaging and protects it from damage
- Makes non-contact transfer and acceptance of the implant easy during the operation
- Three wings with roughened surfaces for non-slip holding make it very easy to handle safely

Symbols on the package labels

STERILER

Sterilization using irradiation



Do not reuse

LOT

Batch code



Manufacturer

REF

Reference number



Expiration date



Keep away from sunlight



Class I medical devices in accordance with Directive 93/42/ECC



Keep dry



Consult instructions for use

CE 0123

Class IIa, IIb, III medical devices in accordance with Directive 93/42/ECC



Note for Russia

Russian certification marking in accordance with the Gos standard



Note for USA

Relevant symbols see product label

Xive® instrument set

Xive® implant drivers

Xive S implants are usually placed with the TempBase, which acts as implant holder and placement head. The implants are held with the Xive implant driver for implants D 3.4 and TempBase, which is fixed to the

head of the TempBase. The implant driver for implants D 3.4 and TempBase is available in the lengths S (short) and L (long); this instrument is always used regardless of the implant diameter.

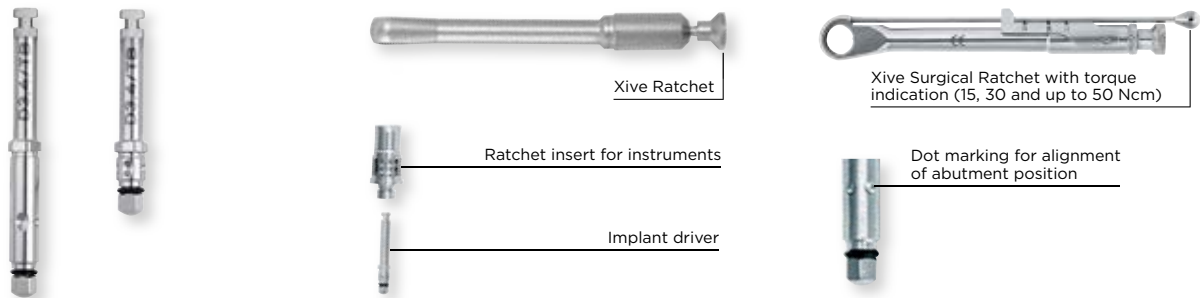

In some cases (torque ≥ 50 Ncm) implant placement using the implant internal geometry (internal hex) may be necessary. In this case the TempBase must first be removed from the implant. Then the implant is picked up with the implant driver for implants, which is selected for the applicable implant diameter, and screwed in to the planned placement depth.

All implant drivers can be used either with the contra-angle handpiece or the Xive ratchet with or without torque indication. The ratchet insert for instruments is required to fix the implant driver to the ratchet. The implant drivers and ratchet and ratchet insert are included in the Xive surgical kit.

Xive implant drivers for implants:

- Available in S (short) and L (long)
- ISO standard shaft for locking into contra-angle handpiece and ratchet insert for instruments
- Hexagon on shaft for use with Frios contra-angle handpieces with hexagonal clamping system for trouble-free placement even in very hard bone, compatible with all other contra-angle handpieces
- Laser marking indicates the use of the instrument (implant diameter, „TB“ for TempBase)

Marking for alignment of implants

Six dots are milled in a circle on the Xive implant drivers for implants. Each dot indicates the center of a face of the internal hexagon and they are used to align the angulated Friadent EstheticBase and the thread for the horizontal screw retention. One dot on the implant driver for implants must point in the vestibular direction in the end position.



Xive Hex Screwdriver 0.9 mm

A Xive hex screwdriver 0.9 mm for use with contra-angle handpiece and ratchet (with ratchet insert for instruments) is also included in the Xive surgical kit. The screwdriver, available in S (short) and L (long), is required to release the TempBase retaining screw and to screw in the implant cover screw.

Essential: Primary stability

During manual placement with the ratchet the surgeon can feel the increase in the resistance to screwing in the implant and has an idea of the final primary stability of the implant. However, the torque cannot be accurately measured with this method. Accurate torque measurement is essential for immediate function of implants.

If immediate or early loading of the implants is planned, a surgical unit with the ability to measure the torque is recommended. The torque indicates the primary stability of the implant at placement. The torque should be a minimum of 35 Ncm if immediate function of the implants is planned.¹

This method also reduces the risk of using an excessive speed for screwing in the implant, which may overheat the bone, because the rotary speed is defined (Frios Unit S/i: 15 rpm).

Bibliography:

1 Neugebauer J, Rogalski S, Zöller JE: Clinical procedure with immediately loaded implants in the posterior mandible - A case report. International Magazine of Oral Implantology 2002; 3 (1): 30-33

Step-by-step: Xive[®] S implant placement

Xive S implants are placed with the Friadent TempBase using the standard protocol. The Xive implant driver for implants D 3.4 and TempBase can be used with the contra-angle handpiece and with the Xive ratchet.

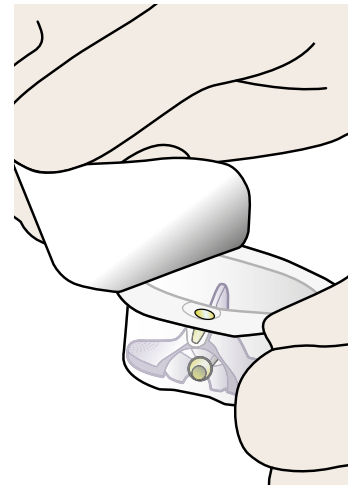
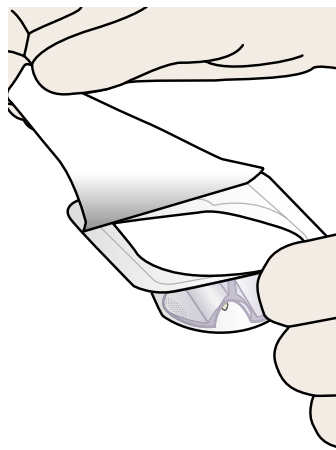
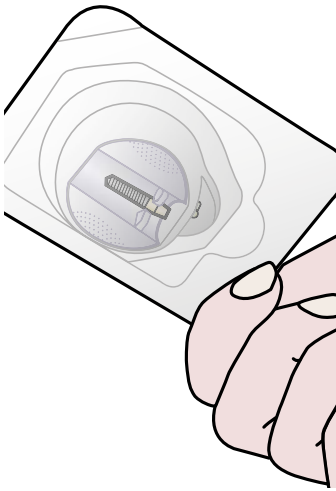

Outer blister

When the implant site has been prepared to the final diameter and the crestal preparation of the cavity with final drilling is complete,

the implant packaging is opened outside the sterile area and the sealing foil of the outer blister is removed.

Xive implant are designed for single use only. A previously placed or non-sterile implant must not be used. The implant must also not be used after the expiry date. Do not interrupt the sterile chain under any circumstances. If immediate or early loading of the implants is planned, a surgical unit with the ability to measure the torque is recommended.

The torque indicates the primary stability of the implant at placement. The torque should be a minimum of 35 Ncm if immediate function of the implants is planned.

Inner blister

The inner blister is transferred to the sterile area without being touched. The sealing foil is removed from the inner blister in the sterile area.

Peel-off adhesive labels with the batch number are on the sealing foil of the inner blister for subsequent documentation in the patient's file or the implant passport.

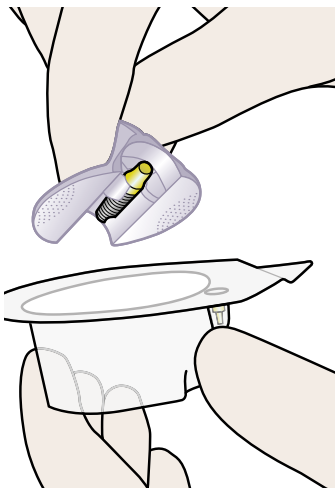

Implant shuttle

The implant shuttle, which holds the implant with the Friadent TempBase, is removed.

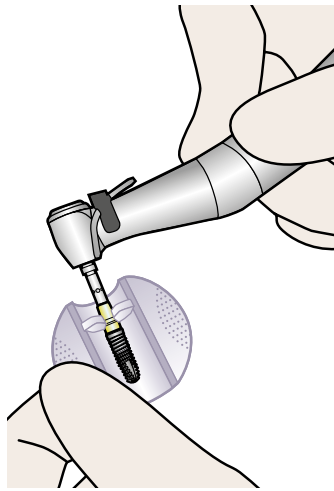

Placing the implant driver

The TempBase, which is screwed to the implant, is picked up with the Xive implant driver for implants D 3.4 and TempBase.

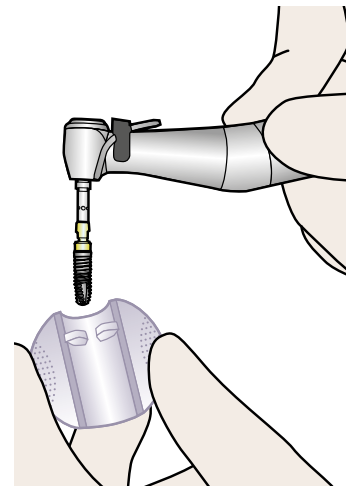

Removing the implant

Then the implant can be removed from the holder without contamination by lightly bending the wings of the implant holder.

Keep the inner blister horizontal when opening and keep it after removal of the implant holder; it contains the cover screw of the implant, which is mounted after implant placement for submerged healing.

Step-by-step: Xive[®] S implant placement

Implant placement with Friadent[®] TempBase following the standard protocol

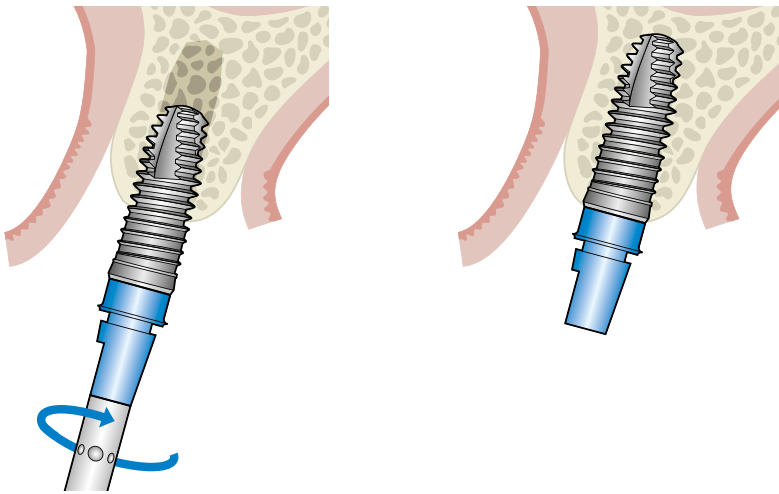

Placing the implant

The implant with the Friadent TempBase is now placed in the cavity with the implant driver and slowly screwed to its final position at maximum approx. 15 rpm.

If a torque greater than 50 Ncm is encountered during placement, proceed as described on page 49.

After placement the structure-polished implant neck must be supracrestal.

Irregularities in the vertical bone height can be compensated by the placement depth.

One dot on the implant driver must point in the vestibular direction in the end position.

The implant driver is then removed from the internal hex of the Friadent TempBase.

Further treatment depends on the planned implant therapy.

Treatment options:

- Submerged healing (see page 48)
- Temporary immediate restoration (see page 56).

The rotary speed when placing implants must not exceed 15 rpm to prevent heat necrosis.

Optional: Placement of Xive® S with the implant internal geometry

If torques above 50 Ncm are encountered during placement of implants using the Friadent TempBase, the

process must be stopped and the Friadent TempBase must be removed from the implant. The implant is brought to its final position using the internal implant-abutment connection in combination with the appropriate implant driver for implants for the diameter.

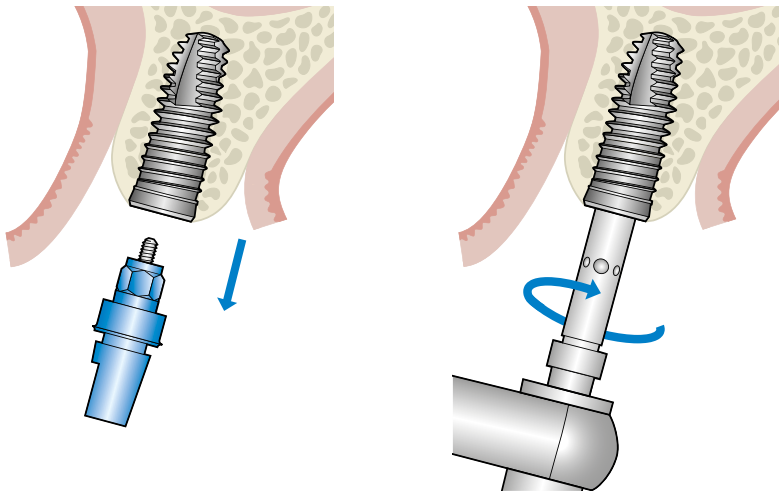

Removing the Friadent TempBase

Before placement by the implant internal geometry the TempBase must be removed from the implant. This is done by slackening the TempBase screw with the hex screwdriver 0.9 mm for ratchet or contra-angle handpiece or with the 0.9 mm hex screwdriver. The retaining screw is locked into the TempBase to prevent its loss. The implant internal geometry can be cleaned and rinsed.

Placing the implant using the internal geometry

The implant is screwed to its final position at maximum approx. 15 rpm with the Xive implant driver for implants, selected to match the implant diameter and fixed to the implant.

Please follow the directions for placement of the implant on page 48.

The implant driver is then removed from the internal hex of the implant.

Further treatment depends on the planned implant therapy.

Treatment options:

- Submerged healing (see page 48)
- Temporary immediate restoration (see page 56).

Step-by-step: Submerged healing

If a two-stage procedure is planned, the implant is sealed with a cover screw during the healing phase to prevent the entry of saliva and bacteria. The color-coded cover screw is fixed in the sterile implant holder.

The screw head, which is only 0.5 mm high and extremely flat, is ideal from an esthetic point of view and for preventing perforation of the mucosa.

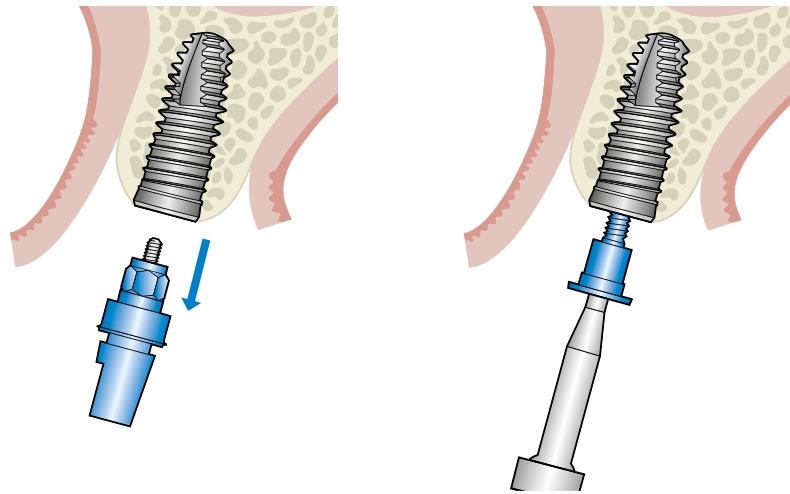

An index impression can be taken during the operation before removal of the Friadent TempBase to allow the implant to be covered. The laboratory can fabricate a high-quality, accurately fitted temporary denture during the healing phase with this impression, which can then be delivered immediately after uncovering of the implants. For the procedure see page 52.

Removing the Friadent TempBase

After implant placement the Friadent TempBase screw is unscrewed with the hex screwdriver 0.9 mm and the complete abutment is removed. The retaining screw is locked into the TempBase to prevent its loss. The implant internal geometry can be cleaned and rinsed.

Placement of the cover screw

The cover screw is removed from the inner blister with the hex screwdriver. The screw is screwed into the implant and tightened at maximum 14 Ncm.



If a two-stage procedure is planned, the implant is sealed with a cover screw during the healing phase to prevent the entry of saliva and bacteria. The color-coded cover screw is fixed in the sterile implant holder.

The screw head, which is only 0.5 mm high and extremely flat, is ideal from an esthetic point of view and for preventing perforation of the mucosa.

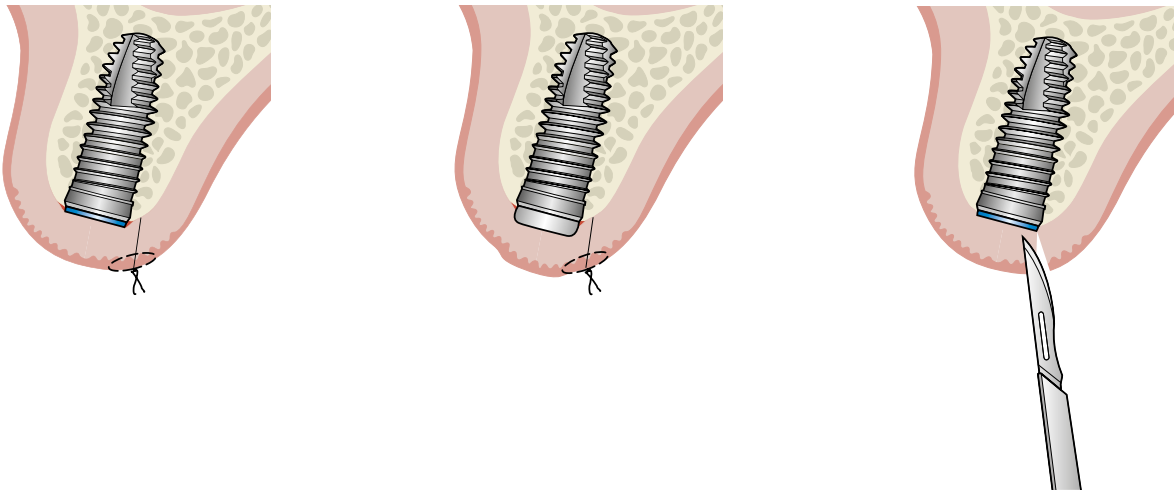

Suturing

The mucosa is replaced and fixed in position by sutures.

Option: Gingiva Former GH 1

Instead of the Friadent cover screws Friadent gingiva formers GH 1 (see page 60) can be used to extend the soft tissue for soft-tissue repositioning during the healing phase.

Exposure

After the osseointegration phase the implant is uncovered for fabrication of the prosthetic restoration. Depending on the planned procedure, gingival-forming components or a temporary denture are placed.

Step-by-step: Temporization

Friadent® TempBase

The Friadent TempBase is multifunctional:

- placement head for Xive S implants
- index impression (with Friadent TempBase cap)
- basis for temporary restorations (with Friadent TempBase cap)



Xive S implants are supplied with the pre-mounted Friadent TempBase. The TempBase is fixed to the implant with the retaining screw. The implant cover screw is included in the implant package. The Friadent TempBase cap, which is required for index impressions and temporary components, must be ordered separately in the required diameter.

The Friadent TempBase

- Titanium alloy
- Friadent color-coding
- Abutment height 6 mm
- 1 mm extension of the lower margin as a preparation limit
- Antirotation lock for secure positioning of temporary abutments

The Friadent TempBase Cap

- Tooth-colored plastic
- Rotation-locked
- Retention by diamond-shaped head and side retention tab
- Coping fits diameters D 3.0 - D 3.8, D 4.5 and D 5.5

The multifunctional characteristics of Xive offer fast and uncomplicated restoration of patients with a temporary denture without replacing components –

which means without any additional risk – and therefore optimum conditions for healing and the emergence profile.

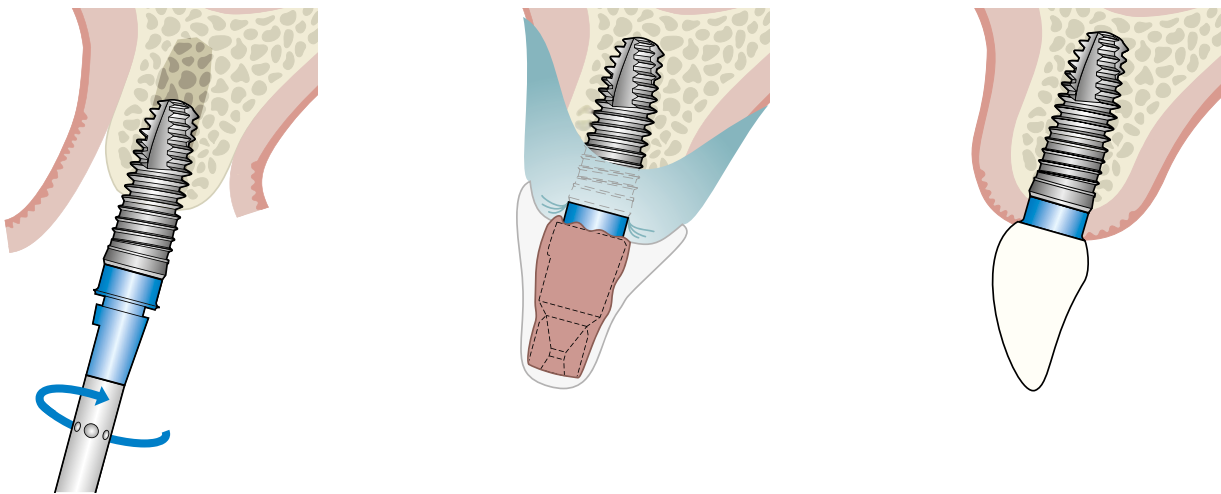

Friadent TempBase as placement head for implants

The implant is removed from the implant holder by inserting the implant driver for implants and TempBase D 3.4 into the TempBase and screwing it into the cavity with the contra-angle handpiece or ratchet. Then the TempBase can remain in the implant for making an index impression or a temporary restoration. If this is not required, the TempBase retaining screw is unscrewed with the 0.9 mm hex screwdriver. Now the TempBase and retaining screw can be removed together. The retaining screw is locked into the TempBase to prevent its loss.

Friadent TempBase for index impression

Immediately after placement of the implants an index impression can be made with the TempBase cap, a prefabricated plastic coping. The laboratory can fabricate a high-quality, accurately fitted temporary denture during the healing phase with this impression, which can then be delivered immediately after uncovering of the implants.

Friadent TempBase as basis for temporary restorations

A high-quality implant-supported temporary denture can be fabricated in a single session at chairside with the aid of the TempBase cap immediately after placement of the implants. This non-functional immediate restoration makes the second surgical procedure for uncovering unnecessary.

Step-by-step: Index impression

The procedure of simplified and accelerated transfer of the clinical situation to the master cast for fabrication of temporary restorations in the laboratory is referred to as implant indexing.

The index impression is done before closing the implant. The temporary denture is fabricated in the laboratory during the healing phase.

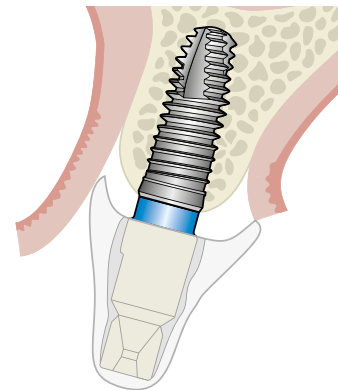
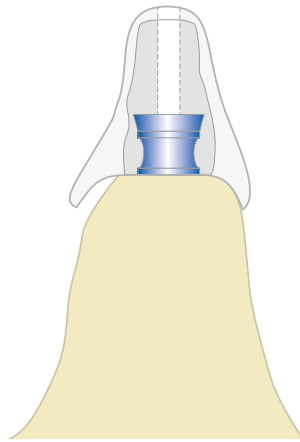
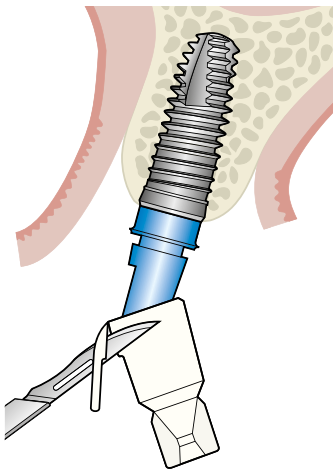

Index impression

The Friadent TempBase remains on the implant or if necessary it is replaced for the index impression.

After removing the side tab a TempBase cap of the right size is pushed onto the TempBase until it clicks into place.

The index impression is ideally done with a drill template fabricated before the operation (on a situation model).

The model is ground to allow it to be placed correctly on the TempBase cap.

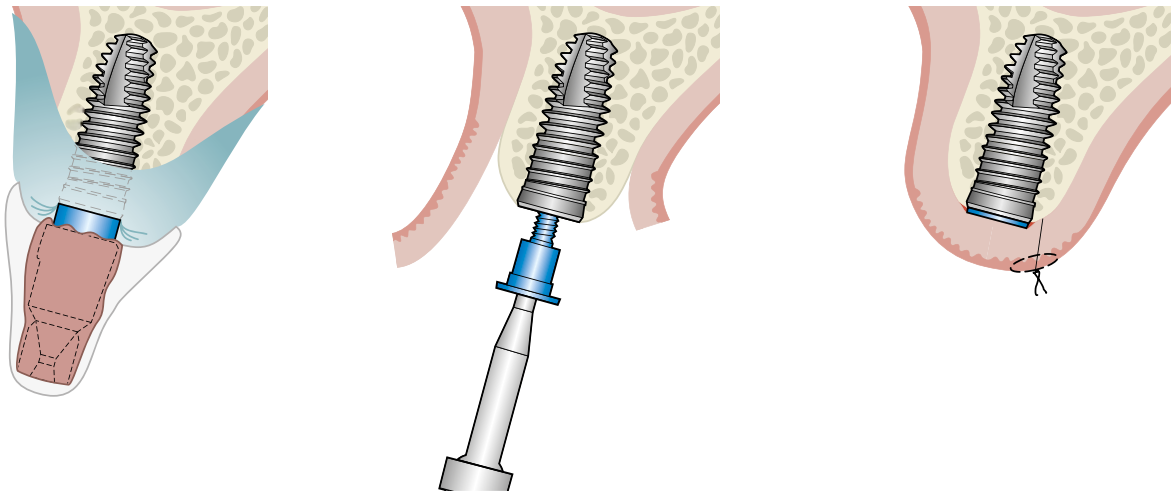

The template is coated with a low-shrinkage polymerizate (pattern resin or light-curing composite, e.g. Cron Mix K plus, Merz Dental GmbH), placed on the TempBase cap and polymerized.

A rubber dam should be placed in the oral cavity before using polymerizates to prevent irritation of the mucosa or an allergic reaction.

Before using polymerizates please see the instructions in the manufacturer's user manual.

Once the polymerizate has cured the template is removed.

The TempBase can also be unscrewed and removed with the hex screwdriver 0.9 mm, then the same screwdriver is used to install the cover screw.

Suturing

Then the wound is sutured to prevent ingress of bacteria and saliva.

The impression and the Friadent TempBase are sent to the laboratory for processing.

After osseointegration the implant is uncovered and the temporary denture prepared on the basis of the TempBase and the TempBase cap is placed in the patient's mouth.

Step-by-step: Index impression

During the healing period, the laboratory fabricates an individual temporary which can be placed in the patient's mouth immediately after uncovering of the implants.

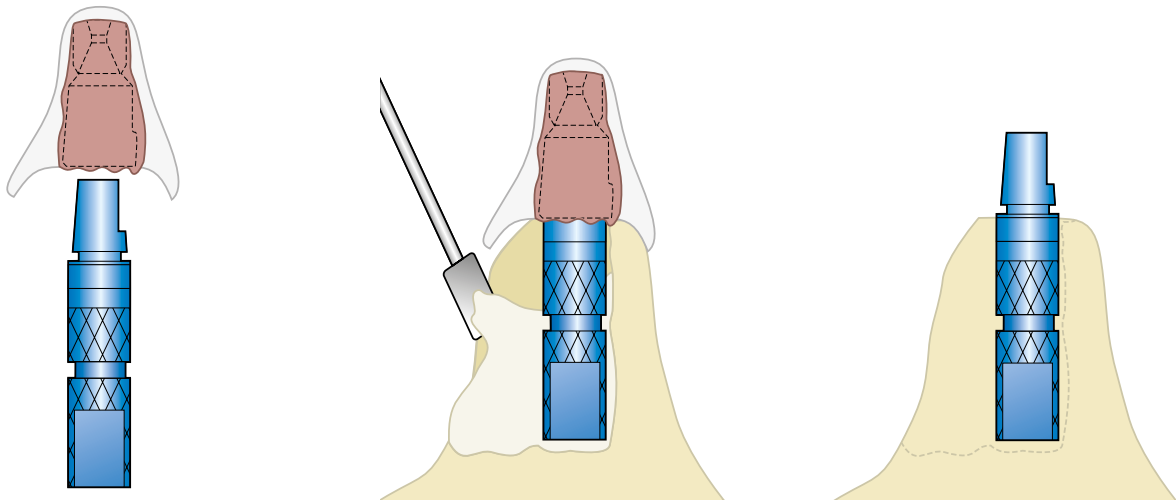

Fabrication of the master cast in the dental laboratory

An implant analog with a Friadent TempBase is screwed into the master cast and transferred to the Temp-Base cap for modifying the master cast.

The technician mills out the area of the implant on the original master cast.

The implant analog is plastered at this position after transfer of the surgical template.

This procedure produces a master cast that shows the exact implant position at the time of implant placement.

Step-by-step: Transgingival healing with temporary denture

Subgingival Xive S plus implants can also be used for transgingival implant healing as well as the classic submerged procedure. Studies^{1,2} show that the retention or early restoration of a functional and esthetic emergence profile will make subsequent restorative surgery unnecessary.

The support and contouring of the peri-implant soft tissue is conducted immediately after implant placement using prefabricated or customized gingiva formers or temporary components.

Studies^{3,4} show that with optimum primary stability micromovements and macromovements (e.g. caused by pressure from the tongue or cheek) at the implant-bone interface can be tolerated up to a threshold value of approx. 150 µm.

Under optimum conditions this will result in successful osseointegration even under non-functional immediate loading.

Friadent® TempBase: the quick „non-functionally loaded” temporary denture

The temporary restoration of Xive implants can also be implemented particularly quickly and accurately at the chairside with the combination of the pre-mounted TempBase with the Friadent TempBase cap (see page 56 and 57). This makes it unnecessary to replace the abutment. The TempBase acts as a temporary crown abutment and the accurately fitted TempBase cap as the basis for fabrication of the temporary reconstruction.

To minimize load transfer the temporary denture should be positioned outside the occlusion.

A thermoformed splint fabricated on the situation model before the operation, which shows the desired shape of the temporary denture, will also simplify the fabrication process. The use of prefabricated auxiliary equipment (such as Frasaco or strip crowns) will save time and money.

Excessive loads by the temporary denture should be eliminated; there must be no occlusal or articulation contact. High primary stability is also desirable. An insertion torque of at least 35 Ncm reduces the danger of macromovements at the implant-bone interface during the initial healing phase.

Bibliography:

1 Khoury F, Happe A: *Soft tissue management in oral implantology: A review of surgical techniques for shaping an esthetic and functional peri-implant soft tissue structure. Quintessence Int* 2000; 31 (7): 483-499

2 Wheeler SL, Vogel RE, Casellini R: *Tissue preservation and maintenance of optimum esthetics: A clinical report. Int J Oral Maxillofac Implants* 2000; 15 (2): 265-271

3 Brunski JB: *Biomechanical factors affecting the bone-dental implant interface. Clin Mater* 1992; 10 (3):153-201

4 Brunski JB: *Avoid pitfalls overloading and micromotions of intraosseous implants. Dent Implantol Update* 1993; 4(10): 77-81

Step-by-step: Transgingival healing with temporary denture

The following example shows the chairside fabrication of a temporary crown using a pre-fabricated plastic tray.

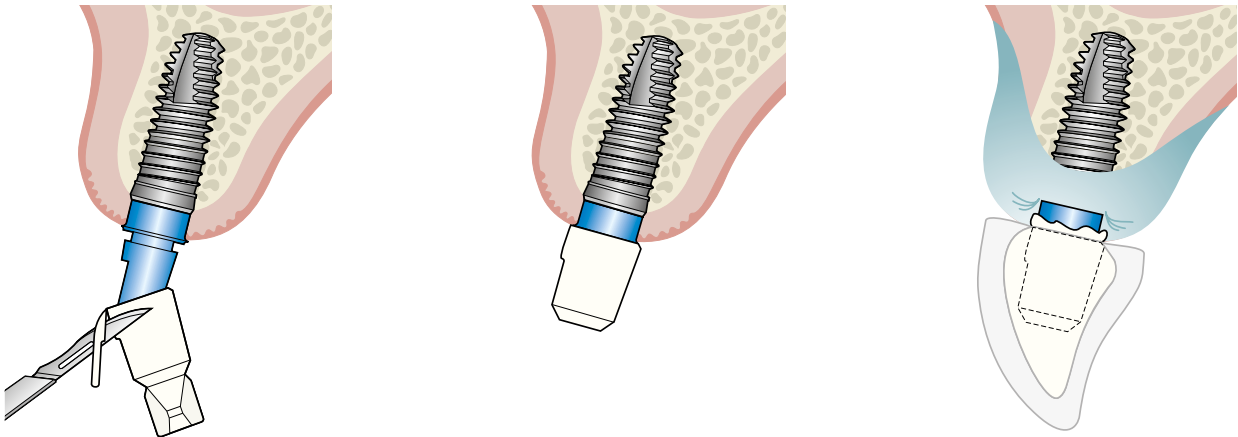

The Friident TempBase remains on the implant or if necessary it is replaced.

For fabrication of a temporary crown the side retention and the diamond-shaped head of the Friident TempBase cap have to be removed.

The modified TempBase cap is placed on the TempBase.

The prepared thermoformed splint or the prefabricated plastic tray (e.g. Frasco) is modified so it can be placed over the TempBase without problems. It is then coated with tooth-colored plastic, positioned and polymerized. A rubber dam should be placed in the oral cavity before using polymerizates to prevent irritation of the mucosa or an allergic reaction.

When fabricating a temporary bridge construction the side retention must remain in place (see page 58).

Before using polymerizates please see the instructions in the manufacturer's user manual.

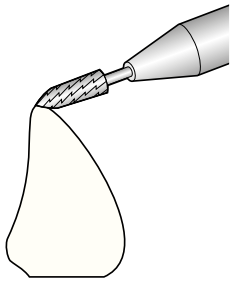

The temporary crown is then removed and trimmed.

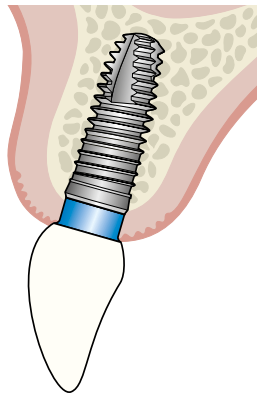

The trimmed temporary crown is placed with temporary cement.

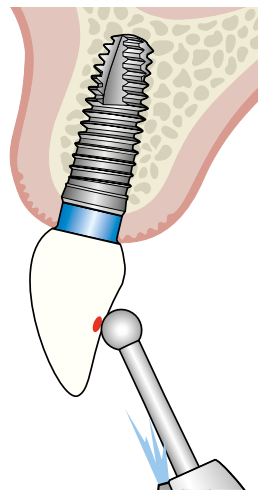

The temporary denture is positioned outside occlusion and articulation.

Step-by-step: Temporary restoration of multiple implant placements

A temporary bridge is fabricated using the same procedure as described above for the case of a single-tooth restoration. However, the Friadent TempBase caps must be firmly connected together with multiple implants.

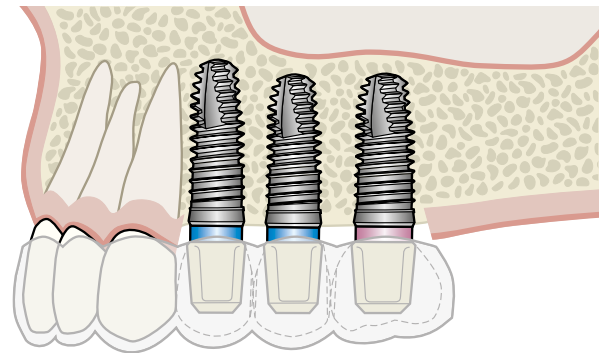
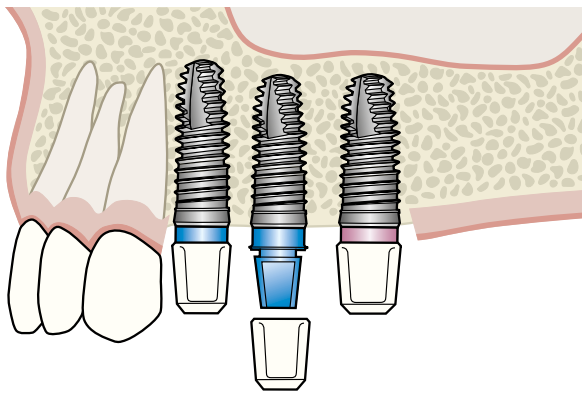

The Friadent TempBase abutments are left on the implants or if necessary are replaced.

After removal of the diamond-shaped head the appropriate Friadent TempBase caps are pushed on the TempBase abutments until they can be felt to click into position.

The prepared thermoformed splint is modified so it can be placed over the TempBase caps without problems and removed after try-in.

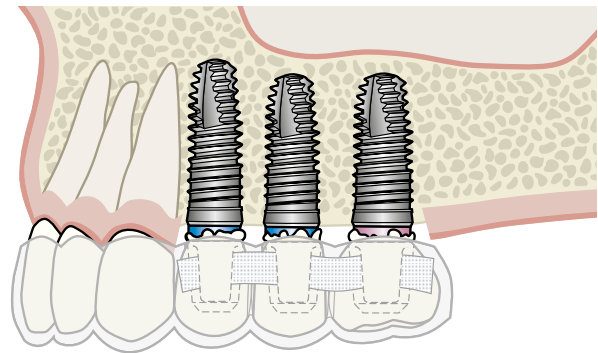
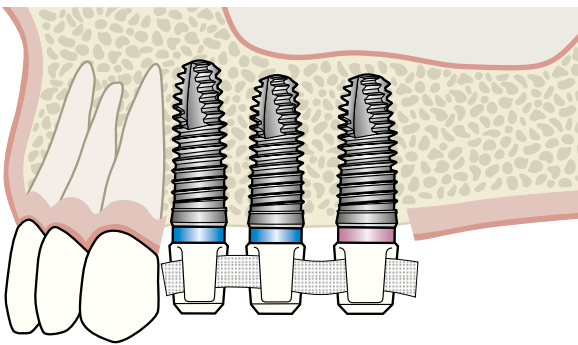

A band coated with light-curing plastic is placed in the side retention tabs to fix the position of the TempBase caps in relation to one another and for mechanical reinforcement of the temporary bridge.

The splint is coated with tooth-colored plastic, positioned, excess material removed and polymerized.

The temporary bridge is then removed, trimmed and if applicable placed with temporary dental cement.

Step-by-step: Transgingival healing with gingiva former

If a single-stage procedure with transgingival healing is planned without preparation of an implant-supported temporary denture, the Xive S implants can be covered with gingiva formers. This is an option where an existing denture can be used as a temporary denture.



A gingiva former is placed for soft tissue contouring during the healing period.



The mucosa is replaced and fixed in position by sutures. (Photos: H. Salama, DMD and M. Salama, DMD, Atlanta/USA)



The Friadent gingiva former effects a rotationally symmetrical contouring of the peri-implant soft tissue by dense deposition of the gingiva on the structure-polished surface.

Friadent gingiva formers

- Titanium
- Structure-polished surface
- Color-coded threaded shaft
- Available gingival margins GH 1, 2, 3 and 5 mm

The following are optionally available:

- **Friadent Gingival Former slim** where space is restricted
- **Friadent Gingival Former Loop** with prefabricated holes through which the suture can be threaded for secure adaptation of the mucosa (suture material up to size 4)

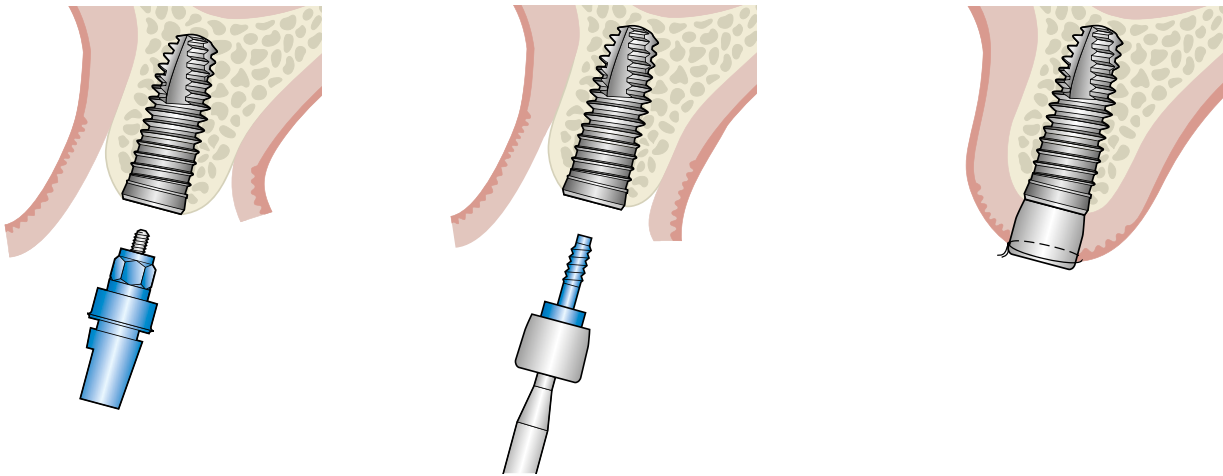

The Friadent TempBase is removed after implant placement using the 0.9 mm hex screwdriver. The retaining screw is secured in the TempBase against falling out. The internal implant geometry can be cleaned and rinsed out.

The appropriate gingiva former is placed with the hex screwdriver 0.9 mm and screwed in at a maximum torque of 14 Ncm.

The soft tissue is adapted and sutured.

An existing temporary denture, such as a clasp denture or a bridge fixed to neighboring teeth, is ground before delivery to ensure that there will be no pressure on the gingiva former.

Xive® TG instrument set

Xive® implant drivers

Xive TG implants are placed via the placement heads screw-retained onto the implant. Just as for Xive S implants, the Xive implant driver for implants D 3.4 and TempBase is used. This is inserted into the internal hex of the placement head. The implant driver is

available in S (short) and L (long) lengths. This instrument is always used, regardless of the implant diameter. The implant driver can be used both with the contra-angle handpiece and the Xive ratchet.

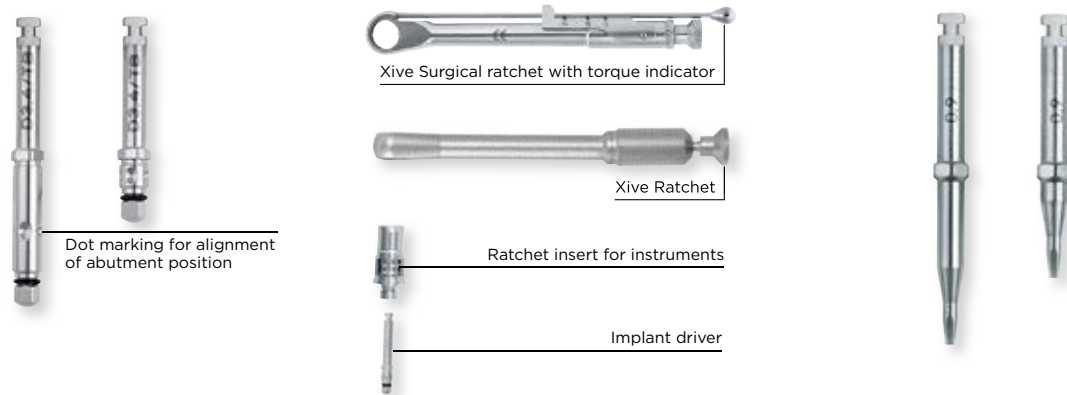

Implant drivers for Xive TG

The ratchet insert for instruments is required for attaching the implant driver in the ratchet. The Xive implant driver for implants D 3.4 and TempBase as well as the ratchet and ratchet insert are included in the Xive surgical kit. Where the implant is placed manually using the ratchet, the practitioner has haptic control over the increase in the screwing resistance and thus over the primary stability of the implant. The screw-in torque achieved, however, cannot be precisely determined using this method. If immediate loading of the implant is planned, machine-driven placement using a surgical unit with a measuring function should be preferred.

Xive implant drivers for implants:

- Available in S (short) and L (long)
- ISO standard shaft for locking into contra-angle handpiece and ratchet insert for instruments
- Hexagon on shaft for use with Frios contra-angle handpieces with hexagon clamping system for trouble-free placement even in very hard bone, compatible with all other contra-angle handpieces.

Xive Hex Screwdriver 0.9 mm

A Xive hex screwdriver 0.9 mm for use with contra-angle handpiece and ratchet (with ratchet insert for instruments) is also included in the Xive surgical kit. This screwdriver, available in S (short) and L (long), is required for loosening the retaining screw of the placement head.

Step-by-step: Xive® TG implant placement

When the implant site has been drilled to the final diameter and the cavity has been prepared by final drilling depending on the bone quality, the implant packaging is opened outside the sterile area and the sealing foil of the outer blister is removed.

The sterile inner blister is removed and the sealing foil is removed in the sterile field (see p. 44). Peel-off adhesive labels with the batch number for subsequent documentation in the patient's file or for the implant passport are on the sealing foil of the inner blister.

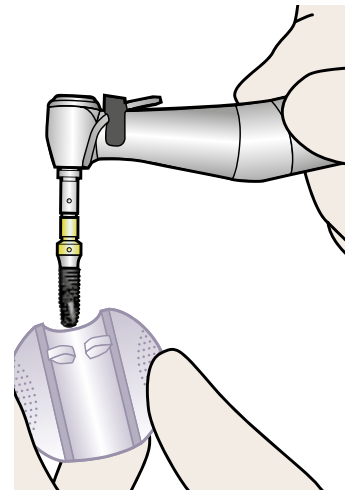
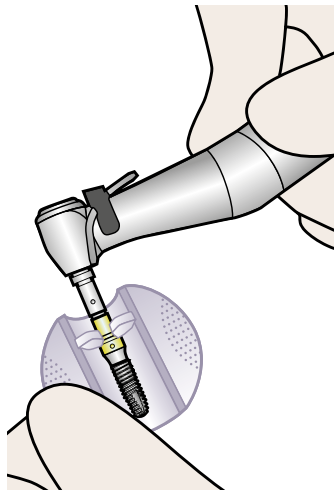

Implant shuttle

The implant shuttle, to which the Xive TG implant with the placement head is attached, is removed.

Placing the implant driver

Insert the Xive implant driver for implants D 3.4 and TempBase into the inner hex of the placement head, ensuring that the instrument is firmly seated.

Removing the implant

The implant can now be removed from the holder without contamination by lightly bending the wings of the implant holder.

Xive implants are designed for single use only. A previously placed or non-sterile implant must not be used. The implant must also not be used after the expiry date. Do not interrupt the sterile chain under any circumstances.

If immediate restoration of multiple implants is planned, this should only be performed if all implants have been anchored with an adequate primary stability. If micromovements at the implant cannot be ruled out, an unloaded healing mode should be preferred.

Where indicated appropriately, Xive TG implants can provide for:

- non-functional immediate loading
- functional immediate loading

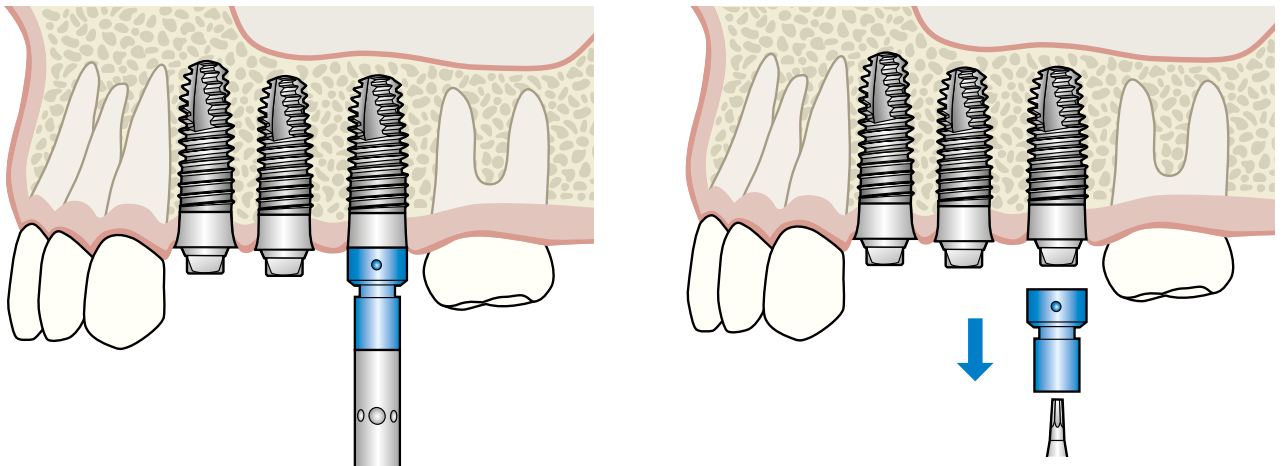

Placing the implant

The implant is now placed in the cavity using the Xive implant driver for implants D 3.4 and TempBase and then slowly, at a maximum of approx. 15 rpm, fixed in its final position. Here, the dots milled on the placement head serve to align the implant. These are positioned over one of the flat sections of the square implant head. After placement, the structure-polished implant neck must be positioned supra-crestally.

Removing the placement head

The implant driver is removed from the placement head, the retaining screw is unscrewed using the Xive hex screwdriver 0.9 mm and the placement head is removed from the implant.

If a torque of over 50 Ncm is reached during placement, the placement head must be removed and the implant must be placed directly using the implant driver for Xive TG implants.

Transgingival healing

Since Xive TG implants are primarily used for functional restorations, the implants can be sealed with a (rotationally symmetric) cover screw for contouring the soft tissues.

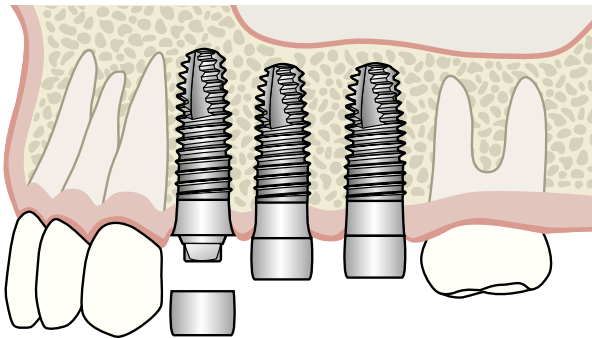

Sealing the implant

After removing the placement head, the implants are sealed with Xive TG implant cover screws. These are placed using the hex screwdriver 0.9 mm with a torque of not more than 14 Ncm.

An unloaded temporary denture (temporary bridge or clasp denture), supported on the adjacent teeth, can be integrated until the healing phase has completed. Xive TG cover screws are not included in the implant packaging and must be ordered separately.

Immediate implant restoration

If an immediate functional or non-functional implant restoration is planned, you should first ensure that the required conditions have been fulfilled. Functional bar-supported immediate loading is only possible if the primary stability of all Xive TG screw implants is adequate (at least 4 screw implants in the mandible).

If immediate or early loading of the implants is planned, a surgical unit capable of measuring the torque is recommended. The torque indicates the primary stability of the implant at placement. The torque should be a minimum of 35 Ncm if immediate function of the implants is planned. To prevent heat necrosis, the rotary speed when placing implants must not exceed 15 rpm.

Guided Surgery

Predictable results with computer-guided 3D planning and placement

The implant placement procedure is planned in 3D with the Simplant software. It provides a complete image of the patient's anatomy for selection and placement of implants and abutments.

The patient-specific designed Simplant SAFE Guide transfer the planning to the patients mouth with high accuracy. The optional lateral access of the guides facilitates computer-guided placement of Xive implants in the posterior region and where space is restricted. All twist drills GS are guided with the Sleeve-on-Drill system in the surgical template. An integrated drill-stop system ensures accurate depth control for every drill.

Xive® implants for computer-guided implantology

Simplant SAFE Guides and Sleeve-on-Drill instruments have been specifically developed for placement of Xive S implants. Xive TG implants cannot be placed through the guide.

Color-coding

A separate color is allocated to every Xive implant diameter, and it can be found on all implant packages, instruments and prosthetic components. The color-coding makes it easy to identify the diameter and select the right prosthetic components without danger of confusion.

Xive S implants for use with Guided Surgery:

Diameter	3.0 mm	3.4 mm	3.8 mm	4.5 mm
Lengths	-	-	8 mm	8 mm
	-	9.5 mm	9.5 mm	9.5 mm
	11 mm	11 mm	11 mm	11 mm
	13 mm	13 mm	13 mm	13 mm
	15 mm	15 mm	15 mm	15 mm

Simplant[®] SAFE Guide – Xive[®]

A custom-made Simplant SAFE Guide is fabricated from the patient's digital planning data using the stereolithography technique. This guarantees the exact and precise transfer of the planning into the patient's mouth.

The unique lateral drill guide access enables an extremely convenient course of treatment, even where space is limited.



Three varieties of drill guides are available for computer-guided implant surgery:

Bone-supported Guide

for optimal, undistorted template seating for f.e. edentulous patients. Ideal in combination with augmentation.

Mucosa-supported Guide

for minimally invasive procedures (flapless surgery) for edentulous patients and where there is minimal remaining dentition.

Tooth-supported Guide

for partially edentulous patients with few missing teeth.

Lateral access

Along with the closed sleeve, a guide sleeve with optional lateral access can also be selected for each implant, with lingual or buccal opening option.

The lateral drill guide access provides additional convenience: it reduces the insertion height of the drill by at least 4 mm, but up to 10 mm, depending on the implant position and the thickness of the mucosa. Thus, effortless template-guided surgery is facilitated in the posterior region and where there is limited space.



Xive® GS (Guided Surgery) instrument set

Specific instruments are available for computer-guided implant placement of Xive S. These are marked "GS" (Guided Surgery) and can only be used together with the Simplant SAFE Guide.



Xive Rotary Tissue Punch GS

The punch is used to make a minimally invasive circular incision in the planned implant position corresponding to the implant diameter.

The tissue punch is used without the drill sleeve, directly guided in the drill guide.

- Laser-marked implant diameter identification
- Color-coding for respective implant diameter
- Internal cooling
- Guided directly in the guide
- Recommended speed: 800 rpm

Xive Initial Drill GS

After using the rotary tissue punch, the mucosa is removed with the initial drill. The bone is "center-punched" as a centering aid for the subsequent twist drill. The initial drill is guided directly in the guide.

- Laser-marked implant diameter identification
- Color-coding for respective implant diameter
- Internal cooling
- Helicoidal chip space for optimal removal of drilling chips
- Guided directly in the guide
- Recommended speed: 800 rpm

Following the incision of the mucosa with the tissue punch GS and centerpunching the jawbone using the initial drill GS, the implant site is atraumatically and precisely prepared using the Xive Sleeve-on-Drill drills until the intended implant diameter has been achieved.

Sleeve-on-Drill™ drill system

Drills specially developed by Dentsply Sirona Implants with a sleeve that can be fixed directly to the instrument guarantee simple and precise guiding of the drill using the guide. The drill stop system ensures exact depth control.



Xive Twist Drill GS

The twist drills have different diameters and are used to prepare the implant site step by step until the planned implant diameter is reached. The twist drill GS D 2.0 is used for the pilot drilling. Xive twist drills GS D 3.0 - D 4.5 are used to expand the implant site until the planned implant diameter is reached. Twist drills are available in the implant lengths and are used according to the length of the planned implant.

All twist drills are used with the Sleeve-on-Drill system and are equipped with a mechanical depth stop. This ensures that the planned drilling depth is not exceeded and that all drilling diameters reach the same drilling depth.

- Laser-marked implant diameter and length identification
- Color-coding for respective implant diameter
- Internal cooling
- Guided with the Sleeve-on-Drill system
- Recommended speed: 800 rpm

Cutting instruments should generally be replaced after 20 cycles of use. Blunt or damaged instruments must be replaced immediately. Gentle, thorough disinfection and cleaning of the drills will ensure that they operate at their best. Please observe the instructions in the cleaning manual. The stainless steel cleaning needle is used to check and clean the internal cooling ducts of the drill. After cleaning the internal channels and the outlets for the cooling liquid with this needle the drills are sterilized in the Xive Surgical Kit GS in accordance with the guidelines (see sterilization instructions, instrument care).



Xive[®] GS (Guided Surgery) instrument set

Sleeve-on-Drill™ drilling sleeves

The Sleeve-on-Drill sleeves ensure that the drill is accurately guided in the drill guide.

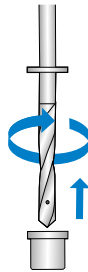

Xive Sleeves for GS Drill

Prior to commencing the operation, the Sleeve-on-Drill drilling sleeves are pushed over the drill tip by turning the drill gently against the direction of rotation and are held in the fixing groove. No instruments are required for this. To prepare the implant site, the drilling sleeves are introduced into the guide sleeve along with the drill and are removed again following the drilling.

- Narrow sleeve (ND) for D 3.0 – D 3.8 implants
- Wide sleeve (WD) for D 4.5 implants
- Disposable articles; sterilize before use
- Not included in the Xive ExpertEase GS surgical kit – please order separately for each case in the ten pack or set

All drilling sleeves are non-sterile on delivery and must be cleaned and sterilized prior to use in accordance with the information in the instructions for use. The drilling sleeves are single patient articles and must be removed from the drill immediately after use.



The definitive implant site for the Xive implants is prepared using the twist drill crestal and the Tap. Unlike the Xive instrument set for conventional surgical preparation, which also contains crestal twist

drills and Taps, the instrument set for computer-guided surgery is only equipped with instruments for use with the contra-angle handpiece.



Xive Twist Drill Crestal GS

The Xive twist drill crestal GS is used for preparation of the cortical bone and is directly guided in the sleeve of the guide.

There are crestal drills available for each implant diameter.

- Laser-marked diameter and length identification and color-coding for the respective diameter
- Internal cooling
- Guided guide sleeve
- Mechanical depth stop
- Recommended speed: 800 rpm at 50 Ncm max.

Xive Tap GS

The Xive tap GS is used after crestal preparation in cortical bone of class D I. Tapping the implant thread before implant placement reduces the insertion torque. A tap is available for each implant diameter.

- Laser-marked diameter and length identification and color-coding for the respective diameter
- Internal cooling
- Guided directly using the guide sleeve
- No mechanical depth stop
- Recommended speed: 15 rpm

Xive® GS (Guided Surgery) instrument set

Implant drivers

The Xive S implants are inserted using the TempBase. GS implant drivers for template-guided implant placement are available for this. Where multiple implant sites are prepared, the guide is secured

against lateral displacement and twisting with the aid of stabilization abutments introduced into the TempBase.



Xive Implant Driver GS

The implant is inserted to the planned insertion depth with the aid of the implant driver. In order to avoid tilting, there must be no pressure placed on the drill guide. The implant driver should preferably be used with a torque-controlled contra-angle handpiece; alternately with a corresponding ratchet insert and the ratchet, ideally with a torque indicator.

- Hex on the ISO shaft for use with Frios contra-angle handpieces with hexagon clamping system for better transfer of the torque (compatible with all common contra-angle handpieces)
- Mark on the shaft to align the abutment position and to monitor the rotational speed
- Guide sleeve is detachable and is screwed on the implant driver; replacement sleeves are available
- Narrow diameter (ND) for D 3.0 – D 3.8 implants and wide diameter (WD) for D 4.5 implants
- Each in long and short variants
- Torque to be achieved: ≤ 50 Ncm

Xive Stabilization Abutment GS

The stabilization abutment is inserted into the TempBase of the implant placed and secures the drill guide additionally against lateral displacement and twisting where multiple implant sites are prepared.

The use of a guide can influence the measurement of the torque with the ratchet.

Step-by-step: Placement of the Simplant® SAFE Guide

The drill guide should be inserted and firmly attached prior to commencing the implant site preparation. The procedure will vary depending on the type of drill used.



Photographs: Dr. Dhom and Partners Practice, Ludwigshafen, Germany

Prior to inserting the guide

Sterilize all components in accordance with the directions in the instructions for use.

Provide all of the drills to be used with Sleeve-on-Drill drilling sleeves and check their fit in the guide sleeves.

Check the correct fit and the correct fabrication of the guide.

If there is any doubt, checking the drilling depth initially using conventional methods and not relying on the mechanical depth stop is recommended.

Organize all the required instruments in the surgical kit GS in order of use.

Step-by-step: Placement of the Simplant® SAFE Guide – Xive®

Bone-supported Simplant® SAFE Guide

A bone-supported drill guide is used for edentulous and partially edentulous patients with more than three missing teeth.

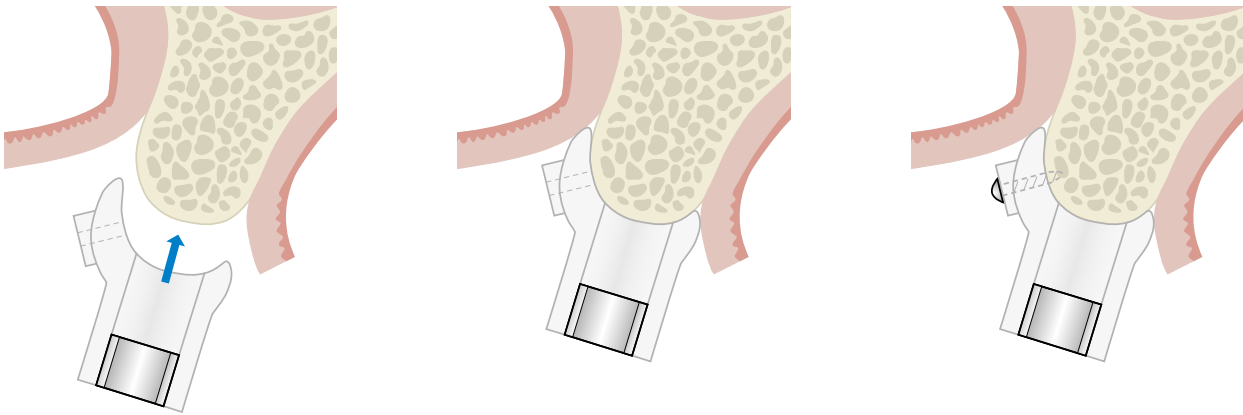

Bone-supported Simplant SAFE Guide

First of all, check the coverage of the guide base. This should only be as large as necessary, in order to guarantee a definite and stable fit. If necessary, grind the base without affecting the stability of the guide or the fixation of the guide sleeves.

When using a bone-supported guide, an incision is made into the alveolar ridge. In the process, the bone should only be uncovered as far as is absolutely necessary to be able to position the guide correctly.

Then, the guide is inserted into the patient's mouth and checked for a precise and stable fit. Then attach the drill guide as required in the designated positions in the jaw.

Check the position, the fit and the stability prior to inserting the guide. The drill guide may only be used if the correct position and an exact fit in the patient's mouth are guaranteed. Excessive force on the drill guide should be avoided: only use fixation screws with guide sleeves and do not over-tighten the fixation screws. Avoid tilting and excessive pressure from the guided surgery instruments. Excessive forces on the drill guide, particularly on the fixation points and the guide sleeves, may result in breaking the guide sleeves or fracturing of the drill guide and rendering these unusable.

Mucosa-supported Simplant® SAFE Guide

Mucosa-supported drill guides guarantee a minimally invasive procedure and are generally utilized for edentulous patients.

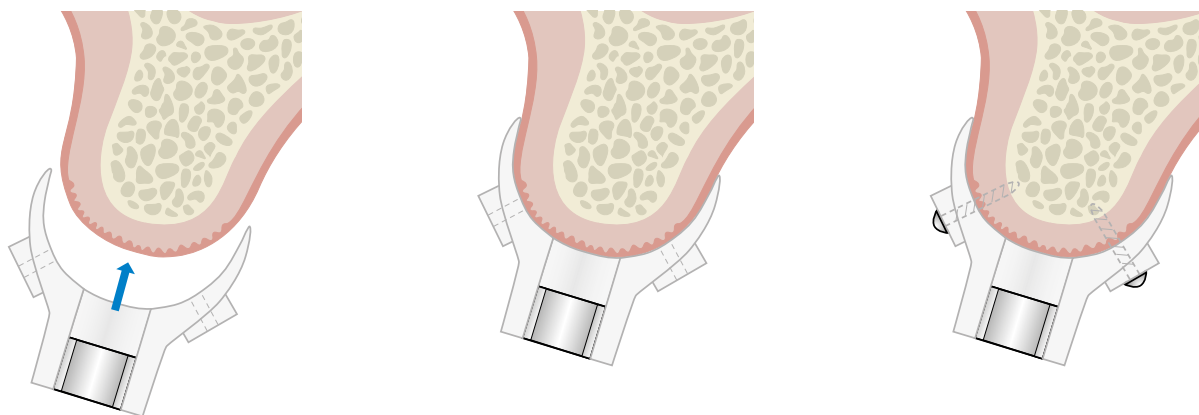

Mucosa-supported Simplant SAFE Guide

Check the fitting of the guide on the plaster model. This must be large enough to guarantee a stable fit. Ideally, the coverage is identical with the scanning template. If the base goes beyond motile structures such as reflections, the floor of the mouth, the labial frenulum or the a-line, grind this as much as necessary without affecting the stability or the fixation of the guide sleeves.

The guide is placed into the patient's mouth and checked for a precise and stable fit.

A check bite made from plastic or registration silicone, fabricated beforehand in the articulator, guarantees that the drill guide records the same position as the scanning template.

Carefully close the patient's mouth and allow him to bite into the registration material. The drill guide is first fixed vestibularly in the designated positions in the jaw. Then, remove the check bite and now, if required, use designated fixation devices also palatally or lingually.

When placing multiple implants, mucosa-supported guides must also be stabilized with stabilization abutments. At least the first two implants must be prepared, inserted and provided with a stabilization abutment before drilling is carried out at other sites. Hence, the drill guide cannot be displaced or distorted between the further drilling processes.

Step-by-step: Placement of the Simplant® SAFE Guide – Xive®

Tooth-supported Simplant® SAFE Guide

A tooth-supported drill guide can be combined using the flapless technique or by folding the gingiva. These drill guides are used for partially edentulous patients or for single gaps.

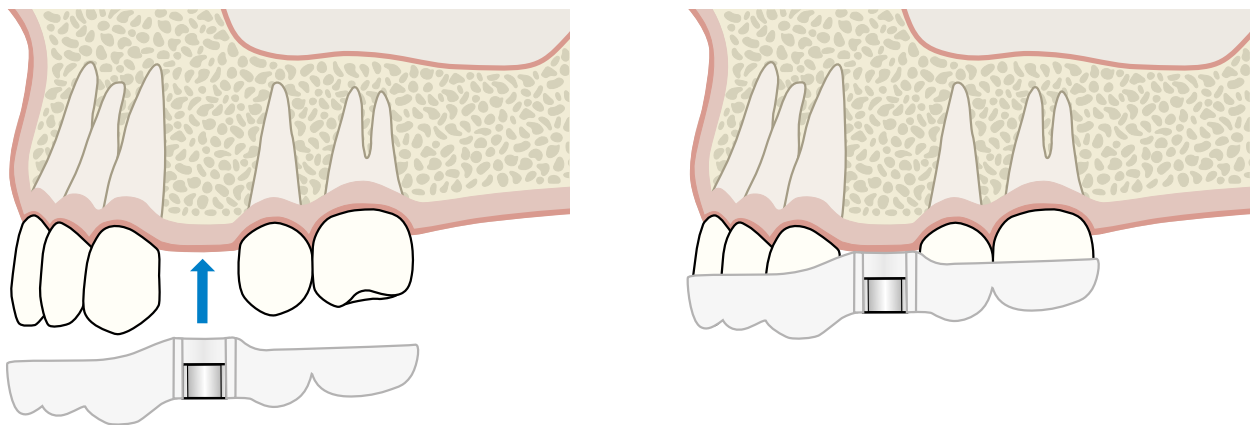

Tooth-supported Simplant Safe Guide

Check the coverage of the guide base and correct this if necessary. Here, depending on the design of the guide, the criteria for bone- or mucosa-supported guides apply to the edentulous regions (see page 74 and 75).

The guide is placed into the patient's mouth and checked for a precise and stable fit. Small openings along the cutting edges and/or the tips of the cusps of the teeth will make checking easier.

Where there is little remaining dentition or an unstable fitting, the drill guide is affixed analogously to the procedure for bone- or mucosa-supported drill guides.

Where there is little remaining dentition or where there is a statically unfavorable structure of the existing teeth, tooth-supported guides must also be stabilized with stabilization abutments when placing multiple implants. In this case, at least the first two implants must be prepared, inserted and provided with a stabilization abutment before drilling is carried out at other sites.

Step-by-step: Preparation of the implant site

The implant site is prepared for the purposes of Guided Surgery using the same steps as for conventional preparation. In the following, the transgingival procedure with mucosa-supported guide is described by way of example. The rotary tissue punch is only required for flapless surgery.

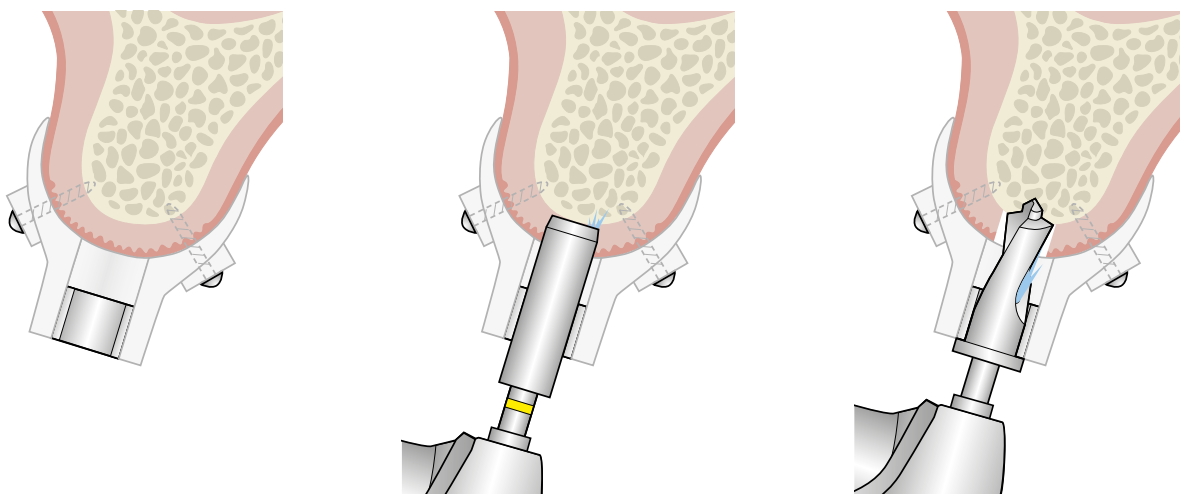

Implants should be inserted in succession: prepare the first implant site, insert the implant, attach the drill guide with stabilization abutment. Then prepare the second implant site, etc. The second implant may only be prepared in any case if the drill guide has been attached after the insertion of the first implant.

Mucosa punching

Connect the internal cooling without the Y adapter for the external cooling and check the flow prior to commencing preparation.

A minimally invasive circular incision of the planned implant diameter is made to the coronal bone margin using the Xive rotary tissue punch GS.

Initial drilling

Using the Xive initial drill GS, the mucosa and the bone coronal up to the implant shoulder are removed and center punched. The pilot drill is guided directly in the guide sleeve.

Be mindful of sufficient internal instrument cooling during the preparation. The opening for the internal irrigation can be obstructed by bone chips during the preparation. Hence, particularly where multiple cavities are prepared in succession, checking the uninhibited coolant flow outside of the guide regularly and, if required, clearing the opening using the drill cleaning instrument are recommended.

Step-by-step: Preparation of the implant site

Where the instruments become damaged or blunt, replace these; replace the instruments, however, after not more than 20 uses. Only use the twist drill a suitable drilling sleeve. Use each drilling sleeve for a maximum of 10 drilling procedures on the same patient. Dispose of all used drilling sleeves immediately after completing the procedure, as the sleeves may later be difficult or not possible to remove from the drill due to adhesion.

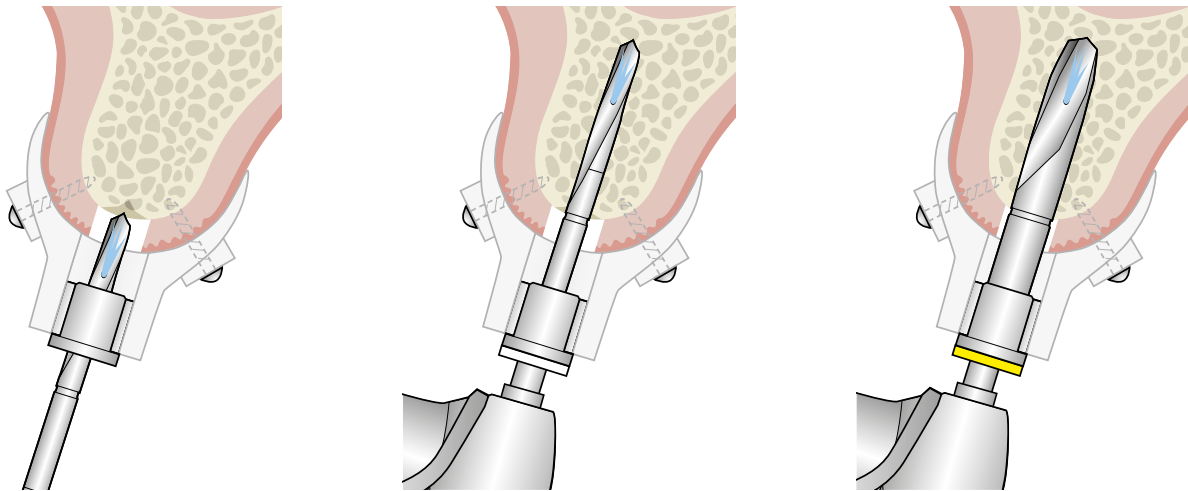

Pilot drilling

The stationary twist drill GS D 2.0 of the planned implant length prepares the pilot hole. For this process, the Sleeve-on-Drill sleeve is locked into place in the first groove above the drill tip. Then lower the drilling sleeve into the guide sleeve of the drill guide to the stop. Do not activate the rotation until this point.

Drill rapidly but without excessive pressure to the drill stop. The still rotating drill is only withdrawn to the original position after reaching the desired depth (no intermittent drilling). Stop drilling after reaching the depth position stop.

Carefully move the drill back and forth, gently pulling, until the Sleeve-on-Drill sleeve is released from the guide sleeve. Both are then removed together from the patient's mouth. If the drilling sleeve in the guide becomes stuck, remove this using pliers or tweezers.

Expansion drilling

After the pilot drilling, the implant site is prepared to the planned implant diameter using Xive twist drills GS of the planned implant length in ascending order.

After reaching the intended implant diameter, the cavity is prepared with the crestal twist drill as required by the clinical situation and the bone class. Subsequently the thread for the implant is tapped in the crestal section of the implant site in cortical bone of class D I with the Xive tap.

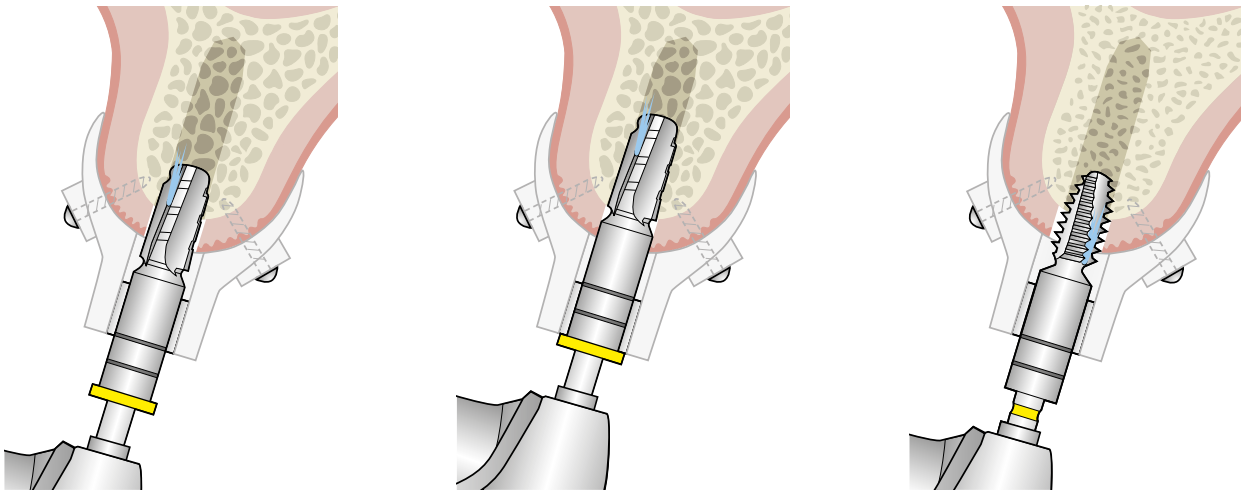

Crestal bone preparation

The crestal region of the implant site is prepared using the twist drill crestal GS that matches the implant diameter as required by the clinical situation and the bone class. The drill has laser markers to indicate the insertion depth.

In cancellous bone (D IV):

If a cortical layer is present, the cavity should be extended 2 mm deep.

In dense bone (D I to III):

Maximum extension of the working length of 6 mm will reduce the internal condensation to just the right extent while the implant is being screwed in subsequently.

The twist drill crestal GS is inserted into the contra-angle handpiece.

The drill is guided into the drill hole by the drill guide and the preparation is commenced in a clockwise direction, under light pressure.

Tapping (optional)

The Xive tap GS is used after crestal preparation in cortical bone of class D I.

The suitable diameter tap is inserted into the contra-angle handpiece. The maximum rotary speed is 15 rpm; the torque is a maximum of 50 Ncm.

Since the tap does not have a mechanical depth stop, the visual control of the maximum preparation depth must be observed. If the tap is screwed in too deeply, there is the risk of damaging anatomical structures and nerves.

Step-by-step: Placement of the implant

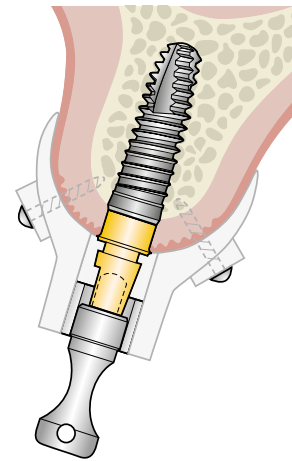
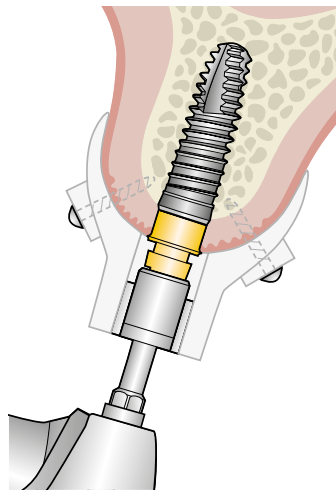
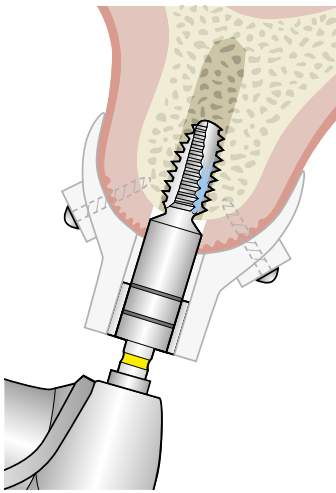

Placing the implant

The tap is guided in the drill guide. Unlike the twist drills previously used the tap is not equipped with a mechanical depth stop. Once the guide shaft is flush with the top margin of the guide sleeve, the maximum preparation depth has been reached. Remove the tap from the cavity in a counterclockwise direction. Then flush with normal saline solution.

The Xive implants are inserted at 15 rpm and a maximum of 50 Ncm via the TempBase with the aid of the Xive implant driver GS. Once the cylindrical part of the implant driver is flush with the top margin of the guide sleeve, the planned implant position has been reached.

If the implant is placed deeper than planned; there is the risk of damaging anatomical structures.

Securing the Drill Guide

Prior to inserting further implants, the stabilization abutment is inserted into the TempBase and secures the guide to prevent it from moving and rotating between preparations of multiple implant sites.

At least the first two Implants must be prepared, placed and provided with a stabilization in succession before further implants are placed.

Notes

Notes

Notes

About Dentsply Sirona Implants

Dentsply Sirona Implants offers comprehensive solutions for all phases of implant therapy, including Ankylos®, Astra Tech Implant System® and Xive® implant lines, digital technologies, such as Atlantis® patient-specific solutions and Simplant® guided surgery, Symbios® regenerative solutions, and professional and business development programs, such as STEPPS™. Dentsply Sirona Implants creates value for dental professionals and allows for predictable and lasting implant treatment outcomes, resulting in enhanced quality of life for patients.

About Dentsply Sirona

Dentsply Sirona is the world's largest manufacturer of professional dental products and technologies, with a 130-year history of innovation and service to the dental industry and patients worldwide. Dentsply Sirona develops, manufactures, and markets a comprehensive solutions offering including dental and oral health products as well as other consumable medical devices under a strong portfolio of world class brands. As The Dental Solutions Company™, Dentsply Sirona's products provide innovative, high-quality and effective solutions to advance patient care and deliver better, safer and faster dentistry. Dentsply Sirona's global headquarters is located in York, Pennsylvania, and the international headquarters is based in Salzburg, Austria. The company's shares are listed in the United States on NASDAQ under the symbol XRAY.

Visit www.dentsplysirona.com for more information about Dentsply Sirona and its products.